

# Operations Manual

## Marksman HHI PLUS Controller

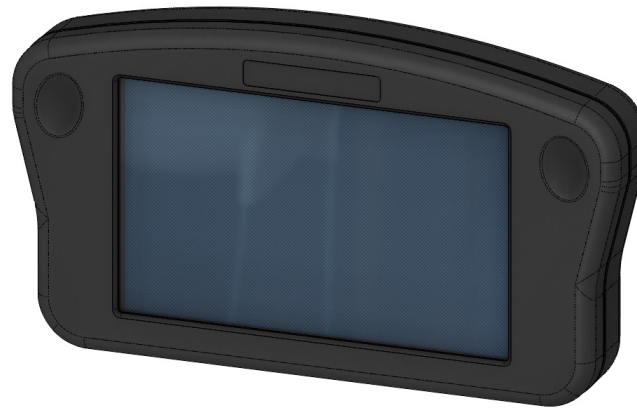

5765-384 FX  
Revision A

# **Marksman HHI PLUS Controller Operations Manual**

---

**5765-384FX  
Revision A**

**The information contained in this manual is correct and accurate at the time of its publication. ITW reserves the right to change or alter any information or technical specifications at any time and without notice.**

**©2017 Illinois Tool Works Inc.  
All rights reserved**

## ***Marksman HHI PLUS***

### **Warranty:**

The Marksman HHI PLUS Controller, including all components unless otherwise specified, carry a limited warranty.

For all warranty terms and conditions, contact the manufacturer for a complete copy of the Limited Warranty Statement.

<b>Section 1: Safety</b> .....	<b>6</b>
<b>Section 2: Controller Functions</b> .....	<b>7</b>
Home Screen .....	7
Message Editor .....	9
Time and Date Codes .....	11
Product Counts, Variable Fields, Logos .....	12
Product Setup, & Menu .....	13
Message Info Box .....	14
The Apps Screen .....	15
<b>Appendix A: Specifications</b> .....	<b>19</b>
Marksman HHI PLUS Controller .....	19
VXJET-IDS .....	20
System Interconnect Diagram .....	21
<b>Appendix B: Theory of Operations</b> .....	<b>29</b>
<b>Appendix C: File System Backup and Restore</b> .....	<b>30</b>
Backup .....	30
Restore .....	30
<b>Appendix D: Configuring a PC to Communicate with a Controller and VXJET-IDS</b> .....	<b>31</b>
<b>Appendix E: Controller and Print Head File Management</b> .....	<b>32</b>
File Manager .....	32
<b>Appendix F: Transferring Logo and Font Files</b> .....	<b>33</b>
<b>Appendix G: ijRemote Application and Multiple VXJET-IDSs</b> .....	<b>34</b>
ijRemote Application .....	34
Operating Multiple VXJET-IDSs with One Marksman HHI PLUS .....	35
<b>Appendix H: Updating the HHI PLUS &amp; VXJET-IDS via USB or Ethernet</b> .....	<b>40</b>

<b>Appendix I: InkJet Demo Software for Windows .....</b>	<b>40</b>
<b>Appendix J: Part Numbers .....</b>	<b>41</b>
VXJET System .....	41
Service Parts .....	42

## Section 1: Safety

Following is a list of safety symbols and their meanings, which are found throughout this manual. Pay attention to these symbols where they appear in the manual.



Caution or Warning! Denotes possible personal injury and/or damage to the equipment.



Caution or Warning! Denotes possible personal injury and/or equipment damage due to electrical hazard.



**NOTE: (Will be followed by a brief comment or explanation.)**



ESD protection should be worn when servicing internal printed circuit boards.

After service to the equipment is completed, replace all protective devices such as grounding cables and covers before operating the equipment.

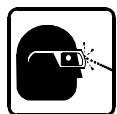

It is extremely important to:

- Clean up all spills with the appropriate conditioner immediately and dispose of all waste according to local and state regulations.
- Wear safety glasses and protective clothing, including gloves, when handling all inks and conditioners.
- Store inks and conditioners under the recommended conditions found on the SDS (Safety Data Sheet).

## Section 2: Controller Functions

### Home Screen

#### Message Window:

- Displays the current print message
- Updated approximately every seven seconds.
- White and/or Beige bars represent the print heads in the daisy chain and are identified by their respective print head numbers.
- The Header displays the task number and file name of the message being printed, if no message is loaded to print, "None" is displayed.

#### Task Select Drop-Down:



- Places focus on the selected task and allows the user to toggle between tasks. This allows one to view what is being printed on either task in the home screen. Additional menu items will vary from one task to the other, depending on print technology.

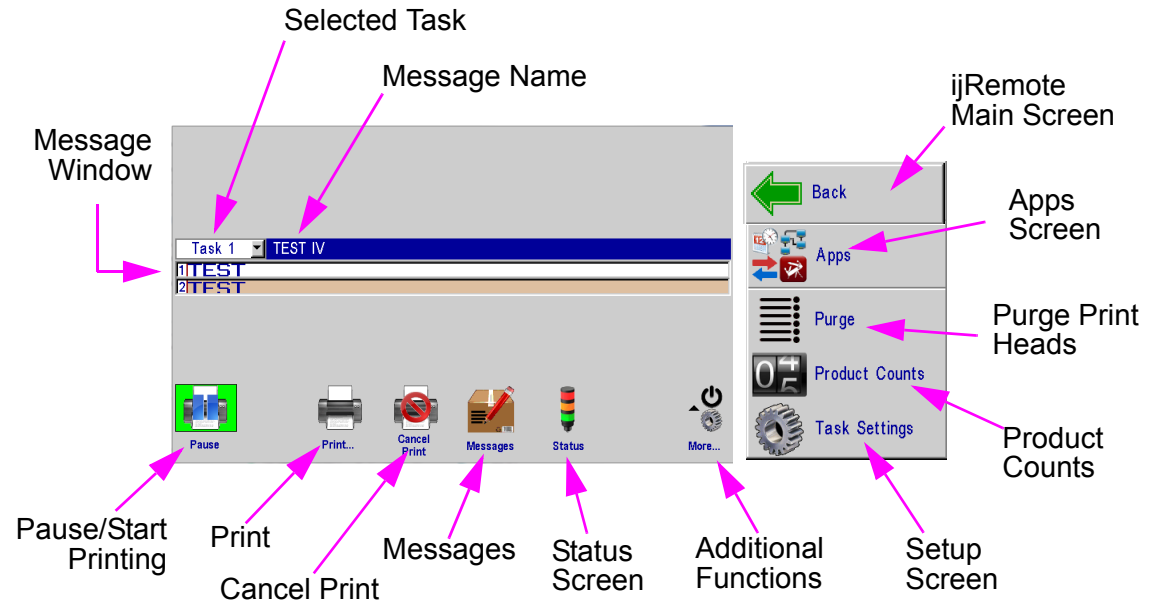

#### Print / Pause Button:

- Starts and Stops print after an operator response to a confirmation dialog popup box.
- If a message is currently printing, pressing the pause button will discontinue printing after the message finishes printing.
- When paused, Pause button will change to Play button. If the Play button is pushed, print will resume on the next product detected.

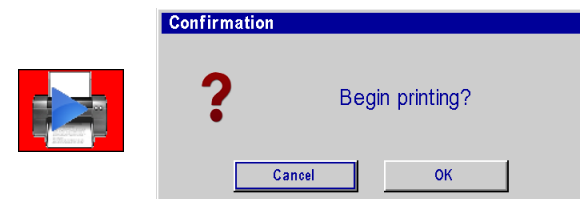
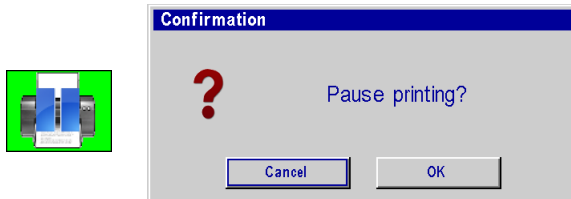

# Marksman HHI PLUS

## Section 2: Controller Functions



### Quick Print Button:

- Allows access to the **Print** dialog box.
- Select the desired message and press the **Printer** button. The message will print at the next photocell trigger.

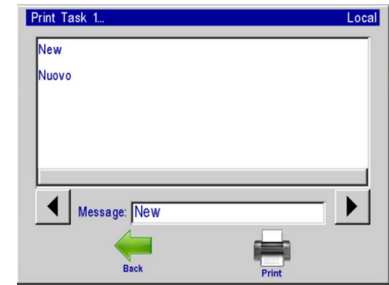

### Purge Button:

- Fires all jets for a short period of time on the selected print head.



### Status Button:

- Version of controller firmware is located in the upper right corner.
- Displays Product detect.
- Displays Printing or Paused status.
- Version of controller firmware.

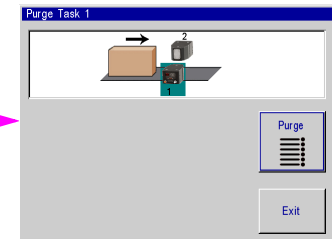
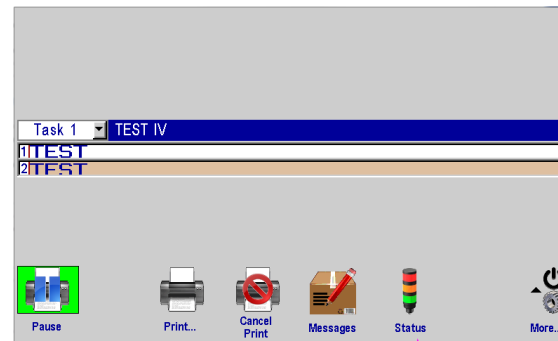

Returns to home screen

Product Detect

Print Status

Line speed

Selected Task

Controller Firmware Version. Press version number to display detailed version information.

Return to Home Screen

**Status** v10.7

- Product detect
- Printing
- Line speed: 1 ft/min
- Ink System 1 2
- Ink level
- Ink lines
- Pressure (psi)
- Status messages
- Task 1 ✓ I/O
- OK



### Message Editor



#### Message Button:

- Press the **Message** button on the Home Screen to bring up the Message dialog.
- To create a new message press the **New** button.
- To edit an existing message, select the message and then press the **Open** button.
- Editing a message or creating a new message will bring up the message editor.
- To delete a message, select the message and press the **Delete** button.

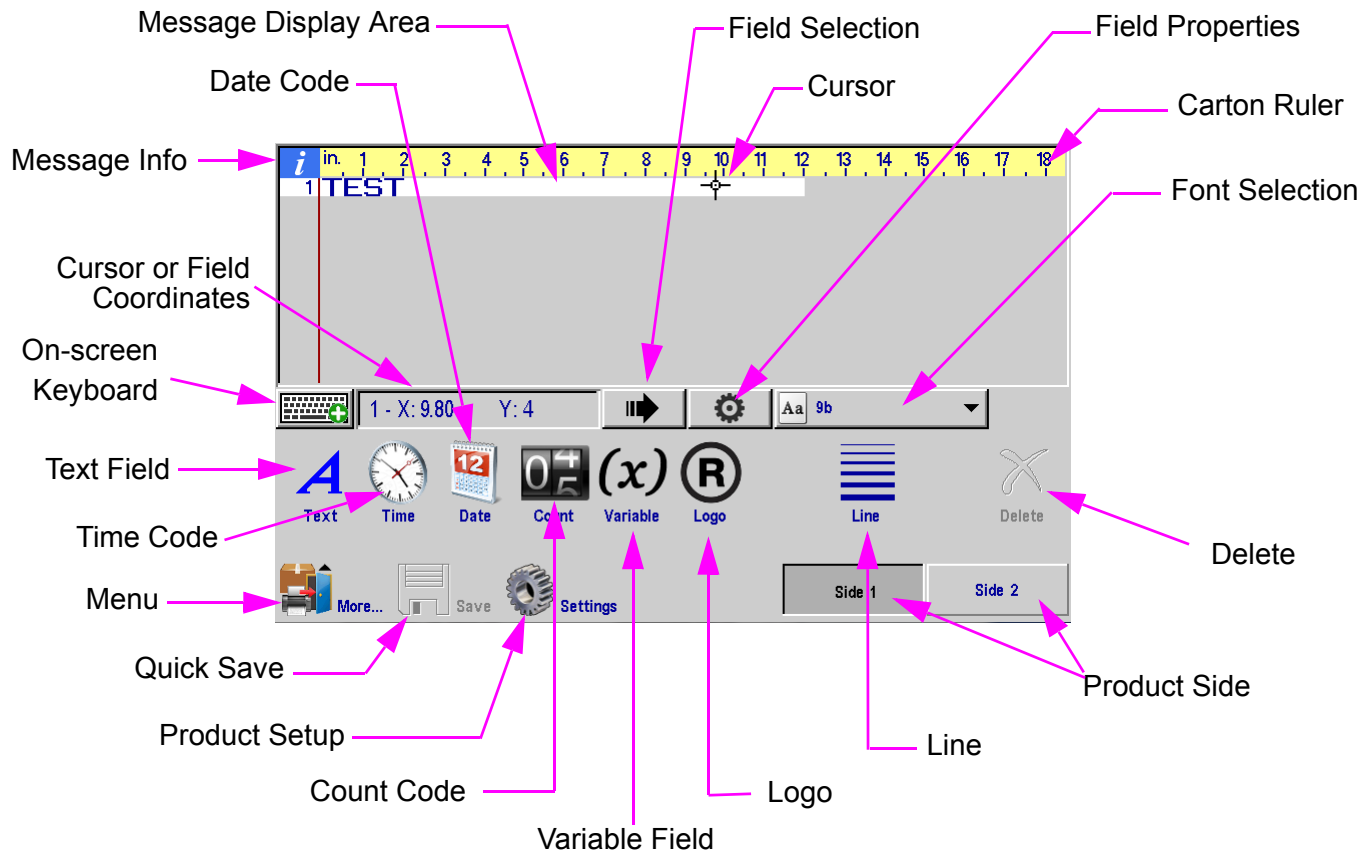
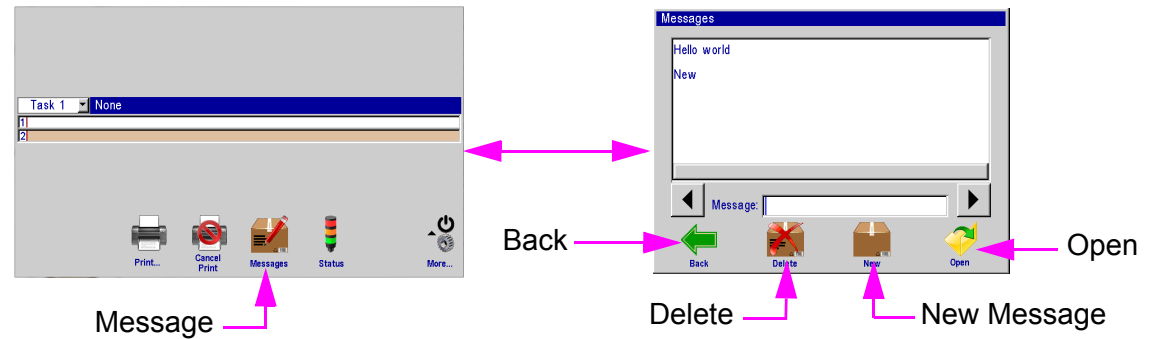



### On-Screen Keyboards & Numeric Keypads

#### Keyboard Button:

- Edit Screen only: Press once to show the keyboard; press again to hide it.
- All other screens and dialogs: Keypad or keyboard appears when text or numeric input box is touched.

#### Layer Select:

- Pressing the **Layer Select** button cycles through; letters, numbers & symbols, and extended characters.

#### Language Select Button:

- Changes keyboard layout to that of the language selected. Changes keyboard layout only; user interface language does not change.

#### ESC (Escape):

- Undoes any changes made to any input entry box. If no changes made, hides the keypad or keyboard.
- Edit screen full keyboard: always hides the keyboard.

#### Arrow Keys:

- Moves highlighted fields or the cursor around in the Message Editor.

#### Tab:

- Switches focus between highlighted fields in the Message Editor.

#### Backspace:

- Deletes the character to the left of the cursor.
- On the edit screen, deletes a highlighted (red) field.

#### Ctrl (Control) in Message Editor:

- Amplifies the movement of the arrow keys.
- Press **Ctrl-Enter** to insert a new line in a text field.
- Can use ctrl-c then ctrl-v to copy and paste fields.

#### Shift:

- Press **Shift** once to make the next character upper case.
- Press Shift twice for shift lock. Press Shift again to exit shift lock.

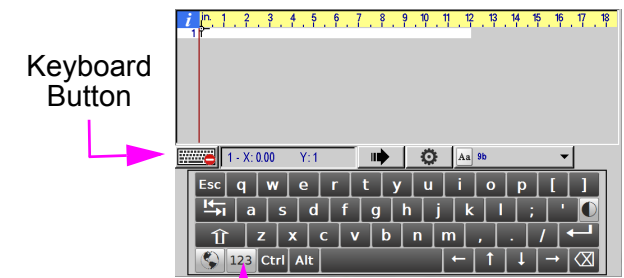

Keyboard Button  
Layer Select

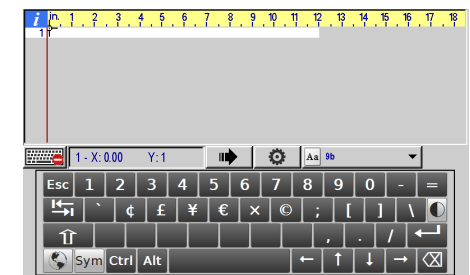

Numbers & Symbols

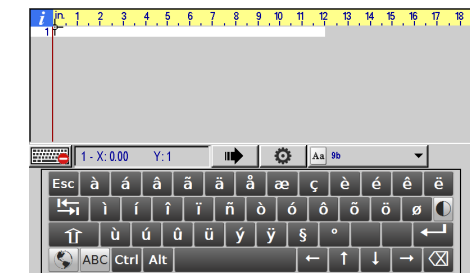

Extended Characters

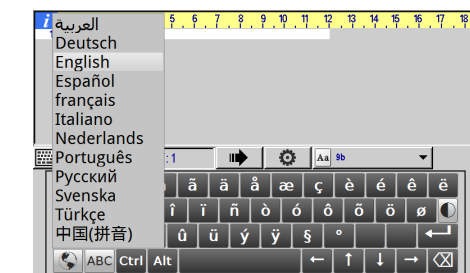

Language Select Button

### Time and Date Codes

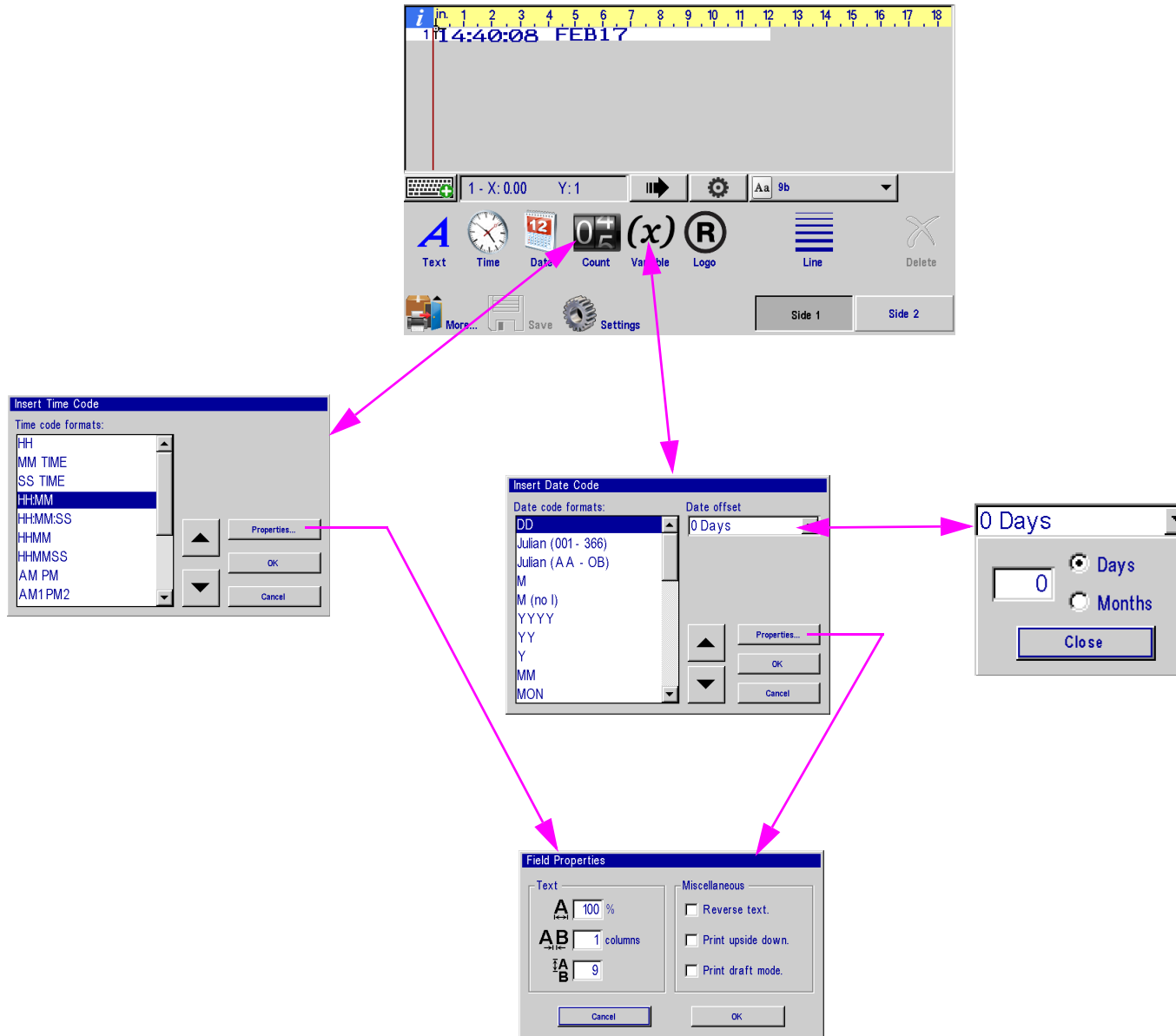

### Product Counts, Variable Fields, Logos

Maximum 9-digit count

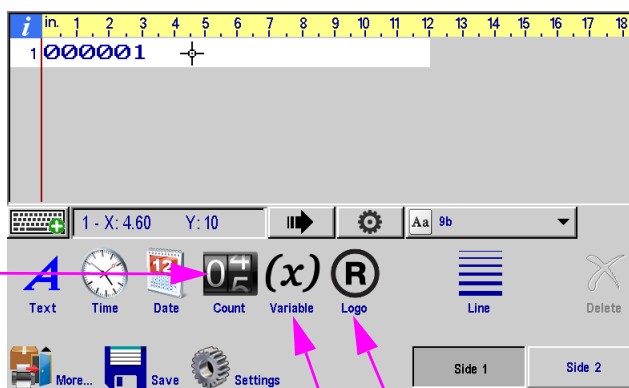

Scroll through logo images or select from list

#### Incrementing Count

Count increments when the 'Start at' value is less than the 'Stop at' value.

#### Decrementing Count

Count decrements when the 'Start at' value is greater than the 'Stop at' value.

#### Variable Field Data Source

**User:** Print data entered when print message containing the variable field is selected to print.

**COM1, COM2:** Data is received through COM1 or COM2 serial port. Data must be received before the message is selected to print.

**Data 1-10:** Data is retrieved from corresponding system variable. User has the option to change the data when the message is selected to print.

### Product Setup, & Menu

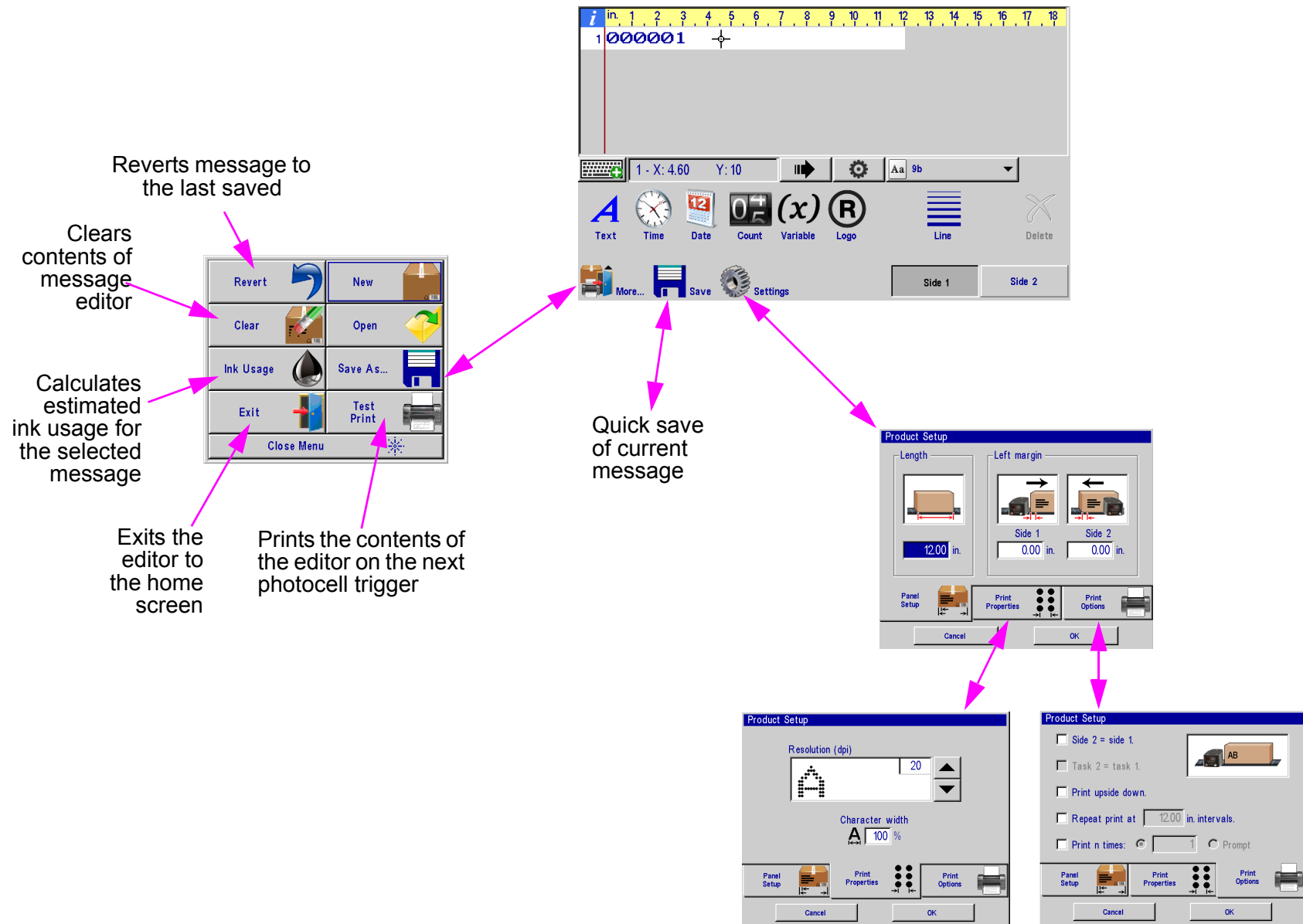

### Message Info Box

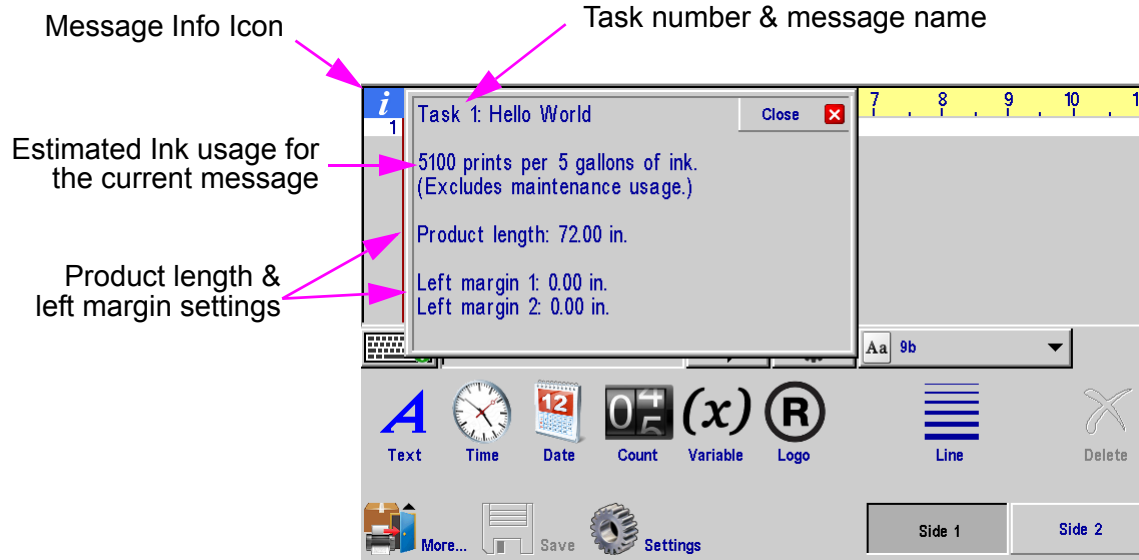

### Direct Entry of Cursor or Field Position

#### Direct Entry Box

**Field:** Selecting the Direct Entry Box while having a field selected will allow the user to manually input the X & Y location of the selected field

**Cursor:** When no fields are selected the Direct Entry Box will allow the user to manually input the X & Y location of the cursor

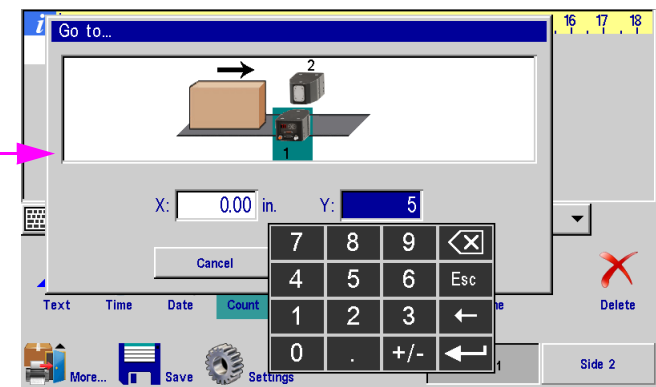
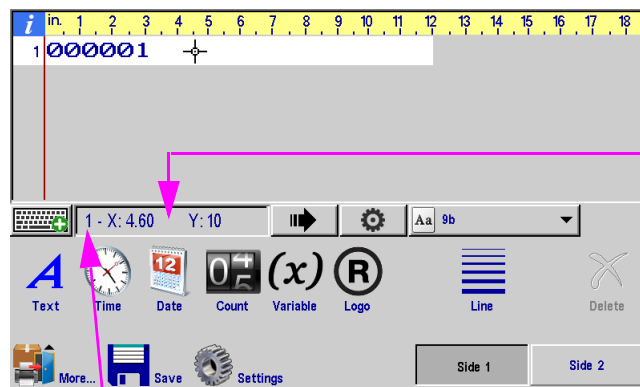

Print Head Number

### The Apps Screen

#### Apps Button

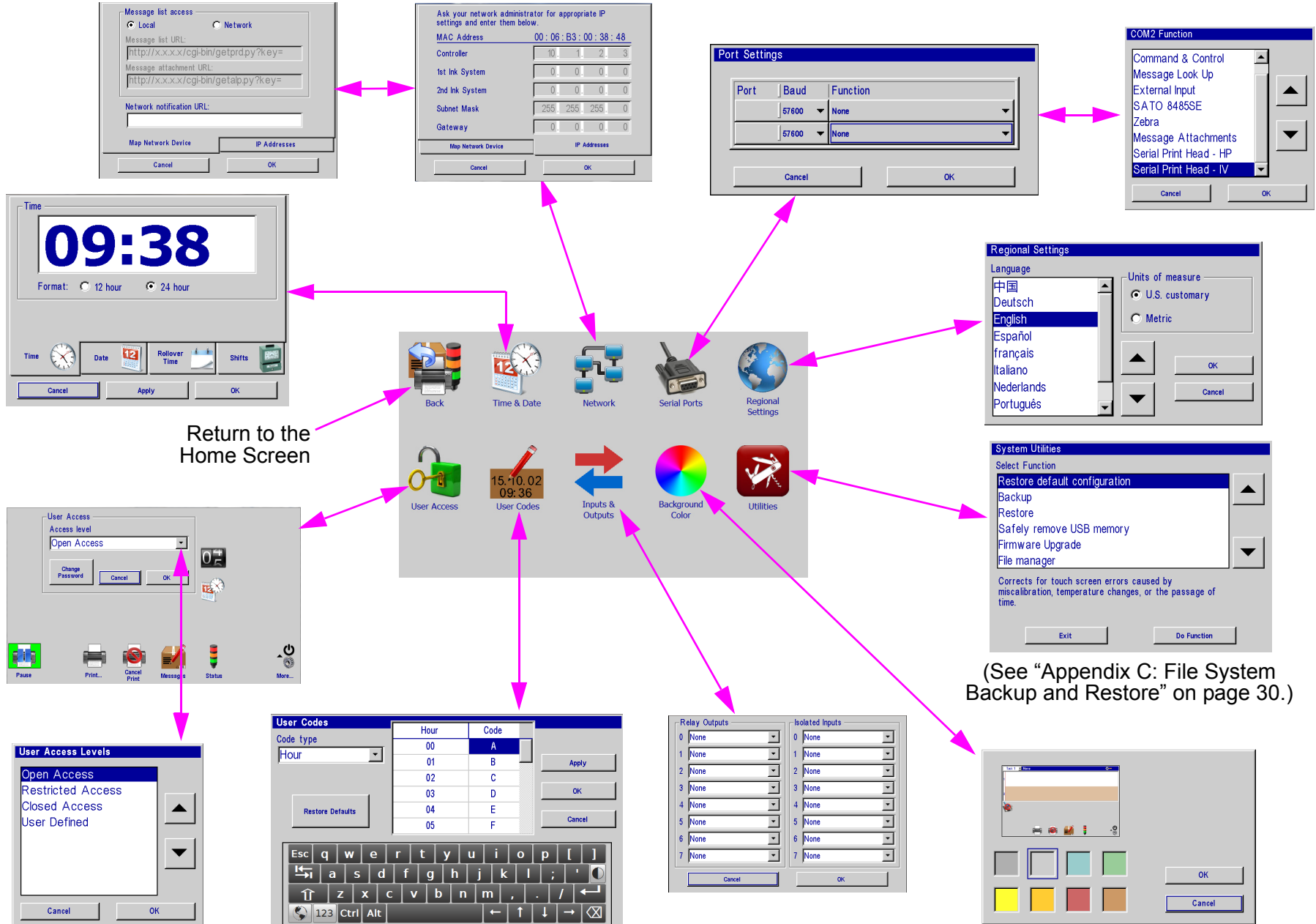

(See "Appendix C: File System Backup and Restore" on page 30.)

### Time, Date, Shifts, and Rollover Time Screen

Set the controller's time and time format

Press "Ok" to return to the Apps Screen

### User Access

Controls within this box set the user access level. Buttons outside the box mirror the Home Screen and indicate which functions are password protected and which are open.

Padlock symbol indicates function is password protected.

The factory set password is **Manager**. Passwords are case sensitive.



**NOTE:** Users can either select a pre-defined access level from the list or they can select "User Defined" and customize their Access settings by selecting icons on the User Access screen.





### User Codes

User Codes are user-defined time and date codes for printing hour, minute, date, month, and week of the year information.

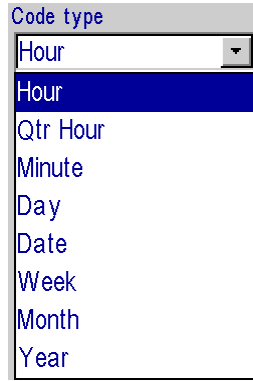

Restore all user codes to the factory default settings

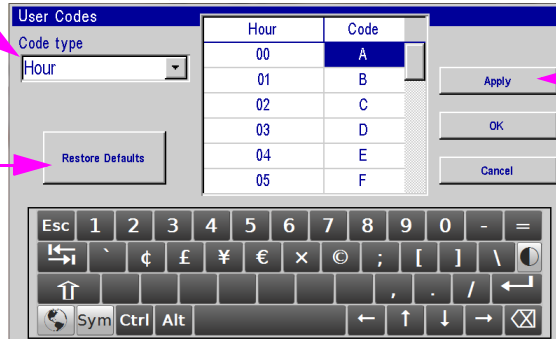
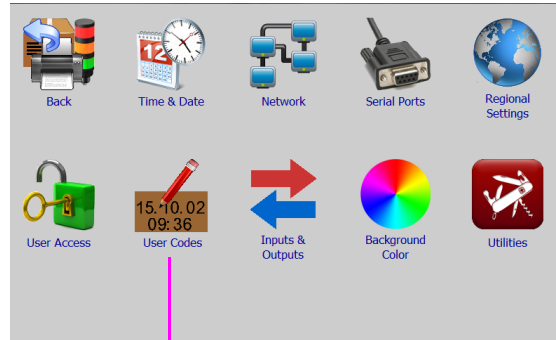

**Apply** allows the user to save and apply changes without exiting the **User Codes** screen.

### I/O (Inputs and Outputs) Status

The I/O Status Screen becomes available when a function is assigned to one or more of the I/O channels. (See the **I/O Board Kit Installation Instructions**, 5760-392N, included in the I/O Board Kit, for directions on setting up the I/O card.) Indicators on the I/O Status screen show the current state of the I/O card's relay outputs and isolated inputs, and are updated every two seconds.

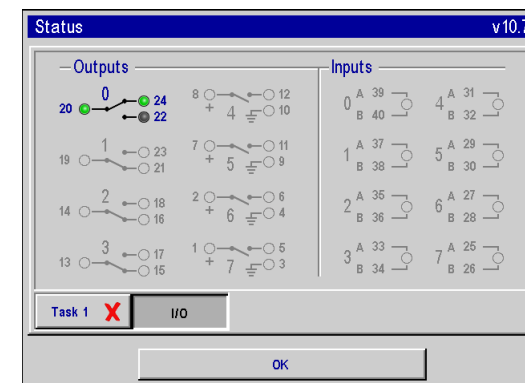

#### Relay Output Indicators:

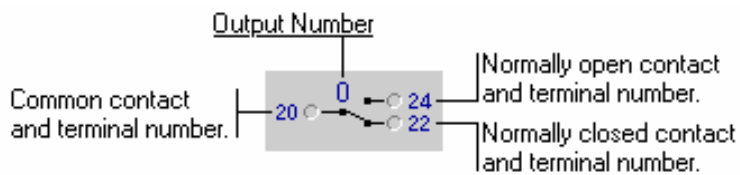

Indicates the output function is undefined, or "None".

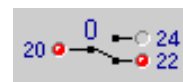

Indicates the relay is de-energized (common contact and normally closed contact are red).

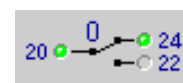

Indicates the relay is energized (common contact and normally open contact are green).

#### Input Indicators:

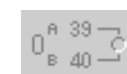
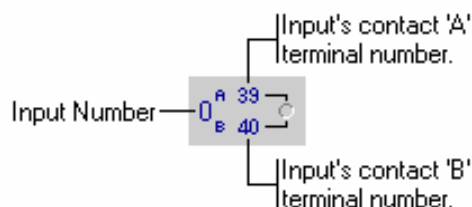

Indicates the input function is undefined, or "None".

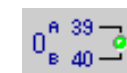

Indicator is on (green); the input signal is active.

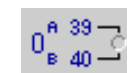

Indicator is off (gray); the input signal is inactive.

#### Manual Control of Relay Outputs

An output relay assigned the **Manual On/Off** function may be manually energized and de-energized from the I/O Status screen by touching the relay's on-screen indicator. Touch it once to energize the relay; touch it again to de-energize it.

## Appendix A: Specifications

### Marksman HHI PLUS Controller

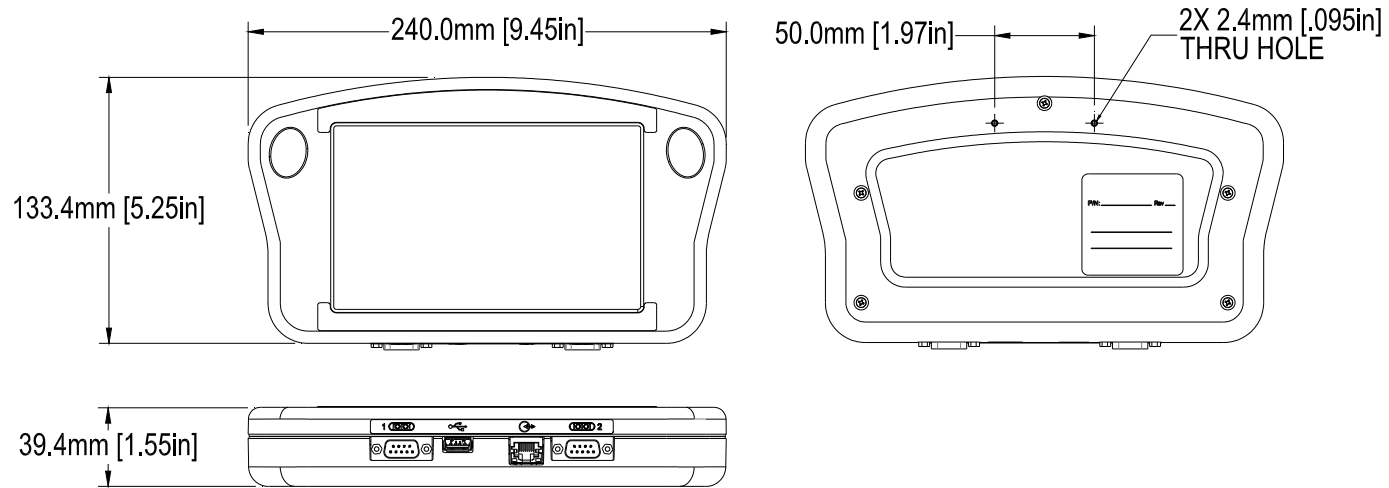

#### **Size**

Weight: .50kg [1.1lb]  
Height: 133.4mm [5.25in]  
Width: 240.0mm [9.45in]  
Depth: 39.4mm [1.55in]

#### **Enclosure**

Black ABS Plastic

#### **User Interface**

Graphical User Interface with  
on screen QWERTY keyboard

#### **Fonts**

Unicode

#### **Display**

178mm [7in] LCD with touch screen,  
800 x 480 pixels

#### **Storage**

512 MB flash memory

#### **Ports**

(2) RS-232 ports, 1 USB port,  
(1) 100 Base-T Ethernet port  
Factory set IP Address: 10.1.2.6

#### **Electrical**

15 VDC supplied from print head power  
supply: 90-260 VAC, 50/0 Hz, 1.5A max.

#### **Environment**

Ambient operating temperature: 5°C to  
40°C (40°F to 104°F)  
Operating humidity: 10% - 90%, non con-  
densing

### VXJET-IDS

#### Size

Weight: 10.1kg [22.2lb]

Height: 336,6mm [13.25in]

Width: 455,8mm [17.95in]

Depth: 142.5mm [5.61in]

Cable and tube Clearance: 76.2mm [3in]  
from the bottom of the enclosure.

#### IP Rating

IP54 (estimated)

#### Enclosure

Stainless steel

#### Ink Filtration

100 micron absolute  
(5760-319 Kit, Ink Filter Assembly)

#### Electrical

15 VDC, 75W and 12 VDC, 3.34A, 40W  
Internal Power Supply

90-260 VAC, 50/0 Hz, 1.5A max

#### Normal Operating Pressure Range

18 psi to 26 psi (approximately)

#### Ports

(2) RS-232 Ports, (1) USB Port

(1) 100 base-T Ethernet Port

Factory set IP Address: 10.1.2.3

#### Environment

Ambient operating temperature: 5°C to 40°C (40°F to 104°F)

Operating humidity: 10% - 90%, non condensing

#### Number of Heads Allowed

Eight (8) IV9Dot or four (4) IV18Dot Print Heads (72 dots total)

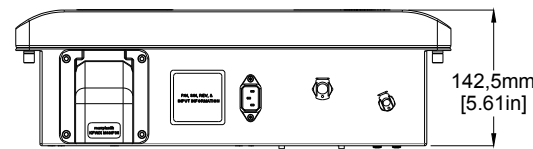
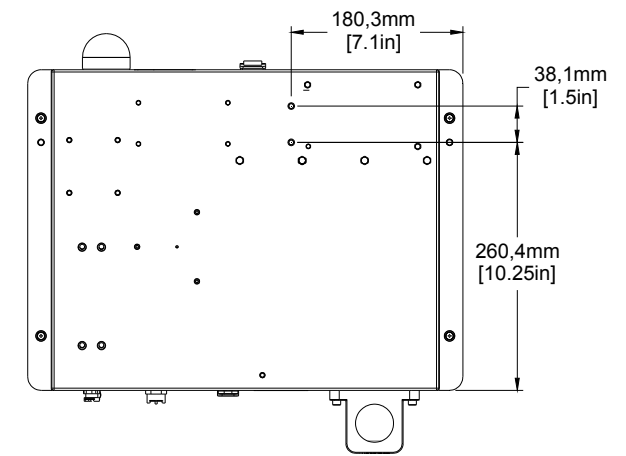
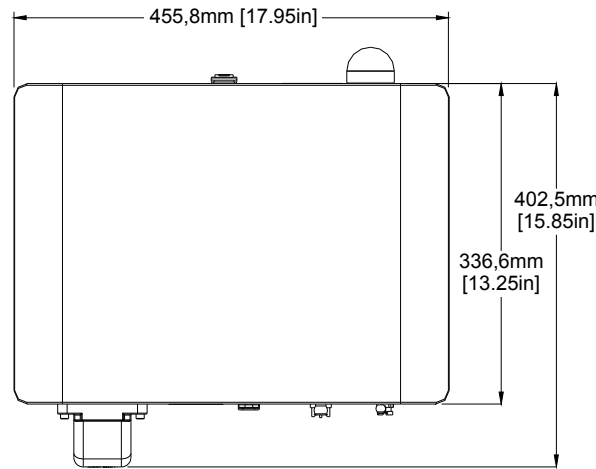

#### Tubing Limitations

Maximum horizontal tube length = 100 ft

Maximum vertical tube length (bottom of VXJET-IDS to bottom of highest print head) = 20 ft

#### Ink Supply Limitations

Maximum height above VXJET-IDS (top of ink supply to bottom of VXJET-IDS) = 8 ft

Maximum distance below VXJET-IDS (top of ink supply to bottom of VXJET-IDS) = 8 ft

Maximum horizontal distance between top of VXJET-IDS and bottom of supply = 8 ft

## System Interconnect Diagram

### Marksman HHI PLUS Controller Board

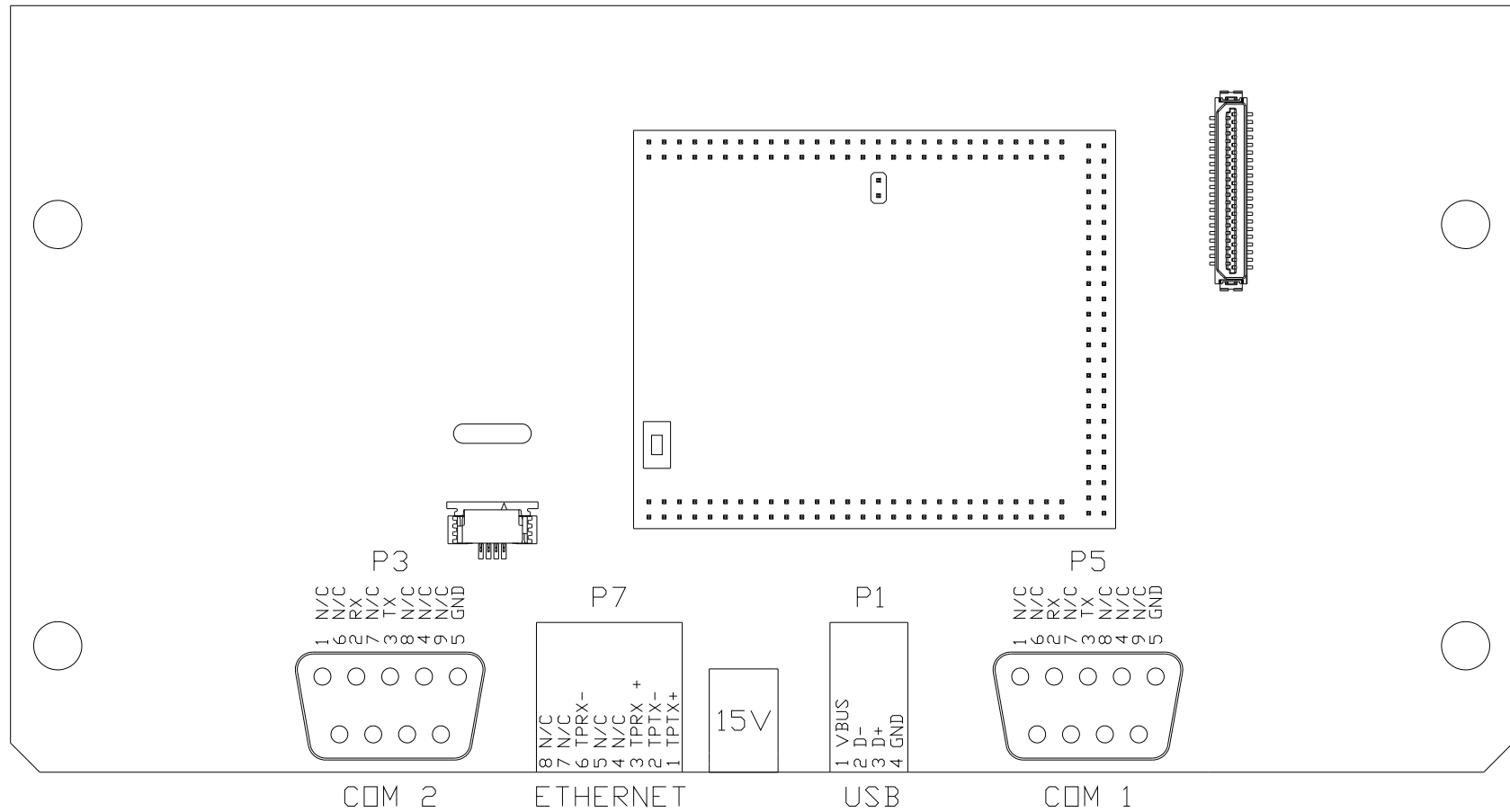



## VXJET-IDS CPU Board

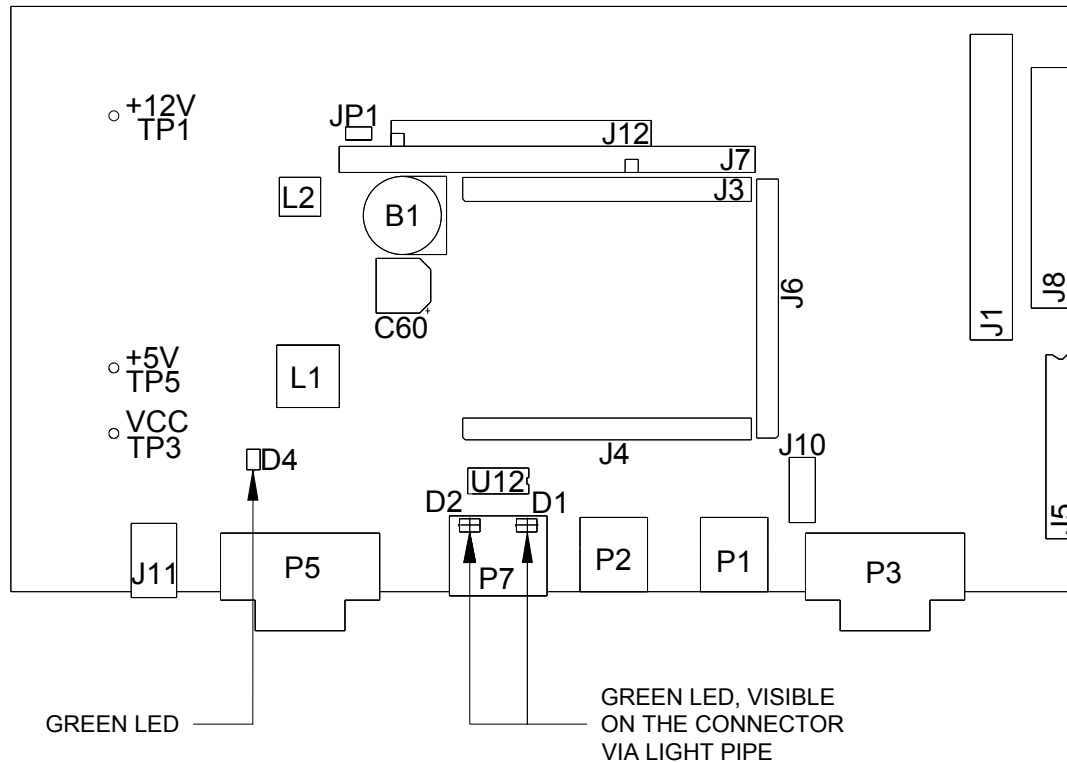

- Test Points:
- TP1: 12VDC, power for display backlight. Turns on/off with soft powerswitch.
  - TP2: 5VDC, power for 5V logic. Also supplies the input voltage to the 3.3V regulator.
  - TP3: 3.3VDC, power for 3.3V logic. Also supplies the input voltage to the 1.8V regulator.
  - TP4: 1.8VDC, power for the CPU core.
- LEDs:
- D1: Ethernet connector, Green. Flashes to indicate network traffic.
  - D2: Ethernet connector, Green. Indicates valid network connection.
  - D1: Yellow, flashes when the CPU is running.(On CPU module)
  - D4: Green, indicates 3.3V is present.
  - D2: Green, indicates 3.3V is present. (On CPU module)

VXJET-IDS CPU Board (continued)

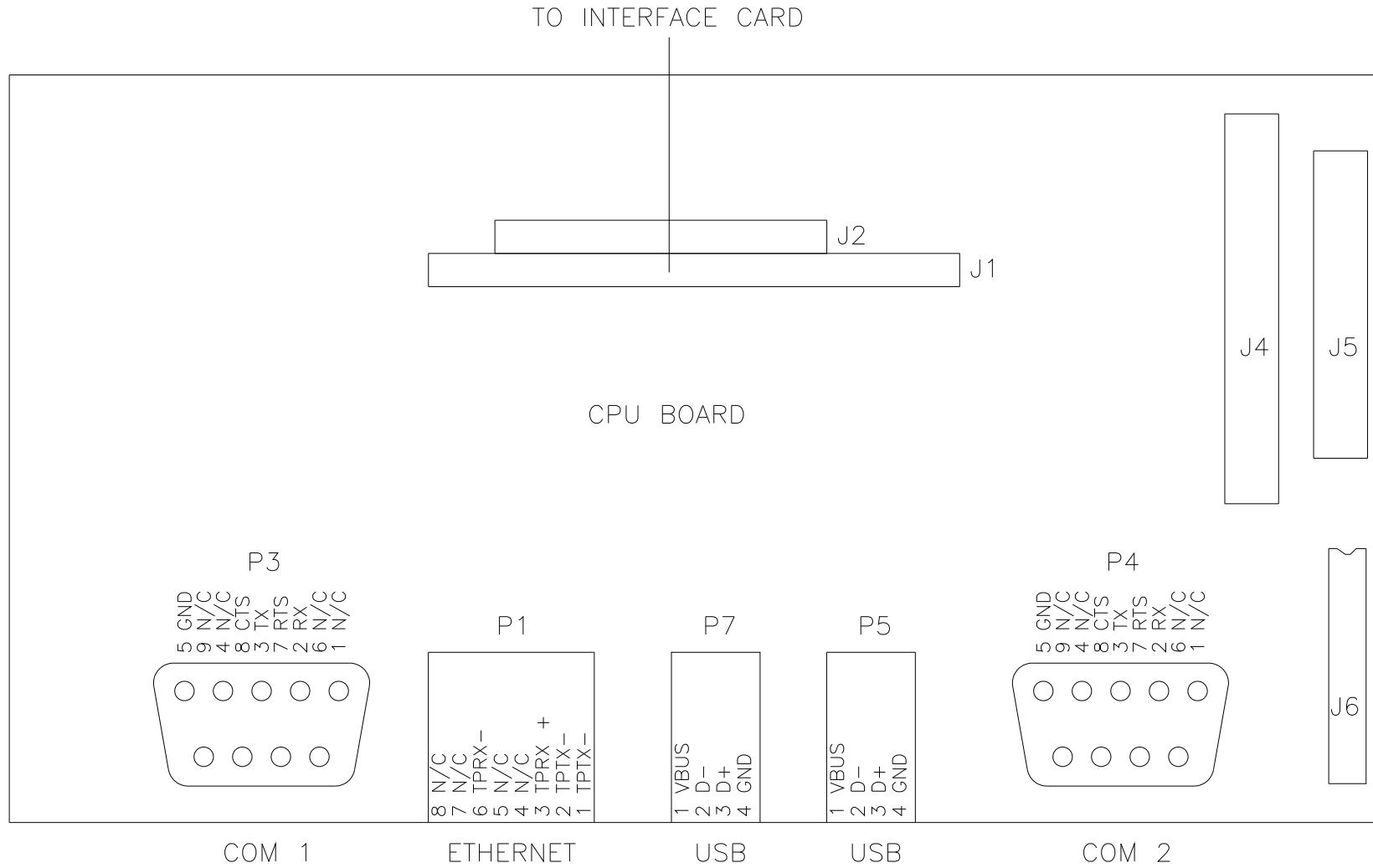



## VXJET-IDS Ink Supply Board

Test Points: TP1, TP4: (TP1 - TP4) = 1.2mV/PSI at the pressure sensor  
 TP2: 0.1V/PSI of pressure  
 TP3: Toggles at the end of a pressure sampling period

TP8: 12VDC  
 TP9: 5VDC

LEDs: LED1: Yellow; indicates the pump is running

Fuses: F1: Beacon fuse, 125V, 1A

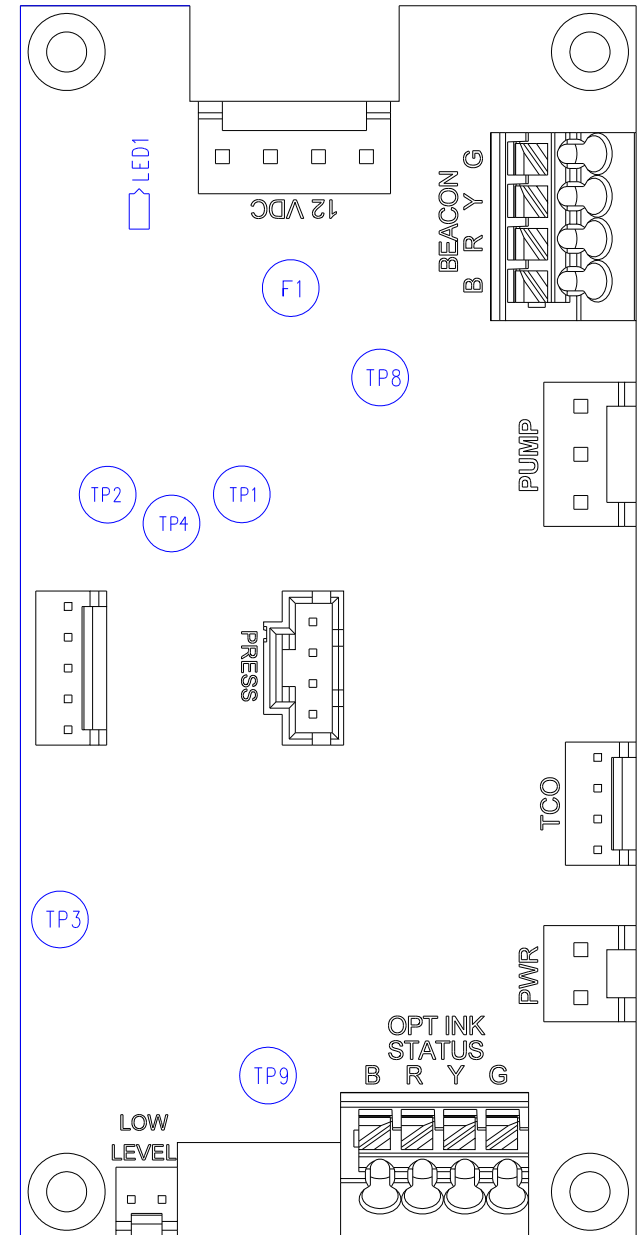

## VXJET Print Head Interface Boards

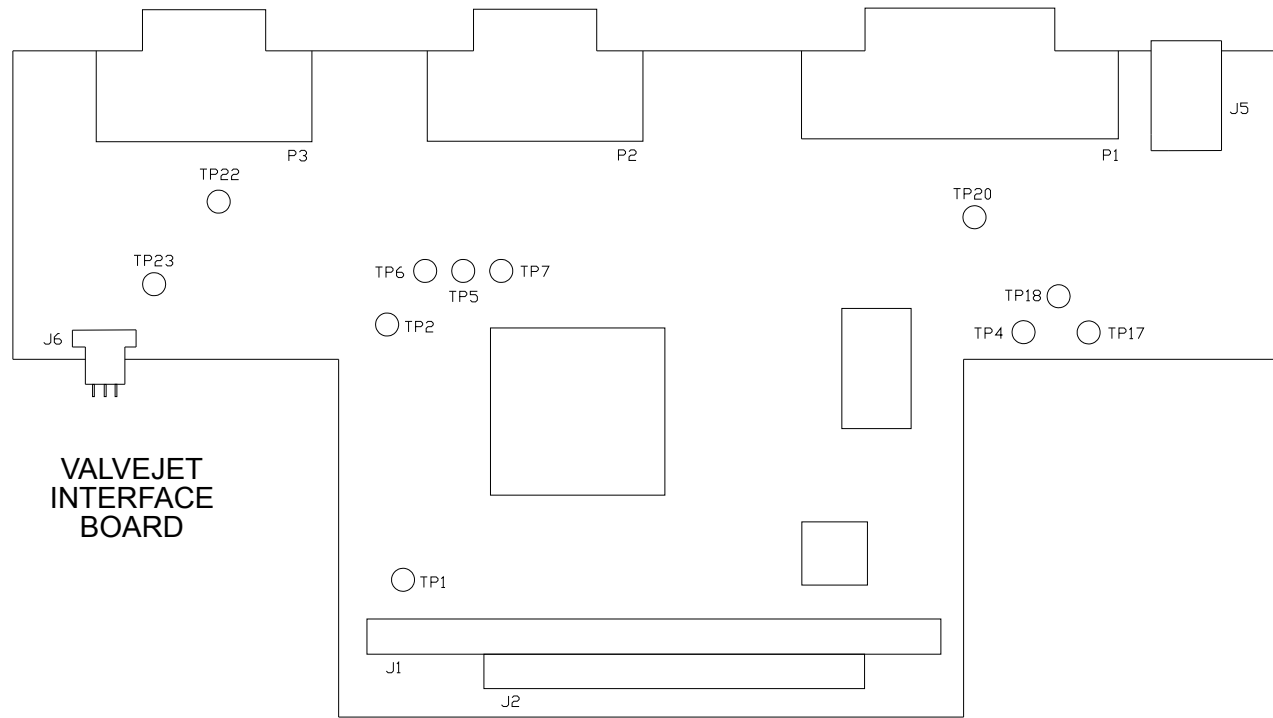

Test Points:	TP1:	5VDC
	TP2:	3.3VDC
	TP4:	GND
	TP5:	(FPGA) PROGRAM; pulses low to initiate FPGA programming
	TP6:	(FPGA) INIT; goes low to indicate an FPGA programming error
	TP7:	(FPGA) DONE. L when the FPGA is being programmed. High when FPGA programming is complete.
	TP17:	DC power in (15V)
	TP18:	Print head CLOCK signal
	TP20:	Print head DATA signal
	TP21:	Print head LATCH signal
	TP22:	PHOTOSENSOR signal
	TP23:	External ENCODER signal

## VXJET Print Head Interface Board

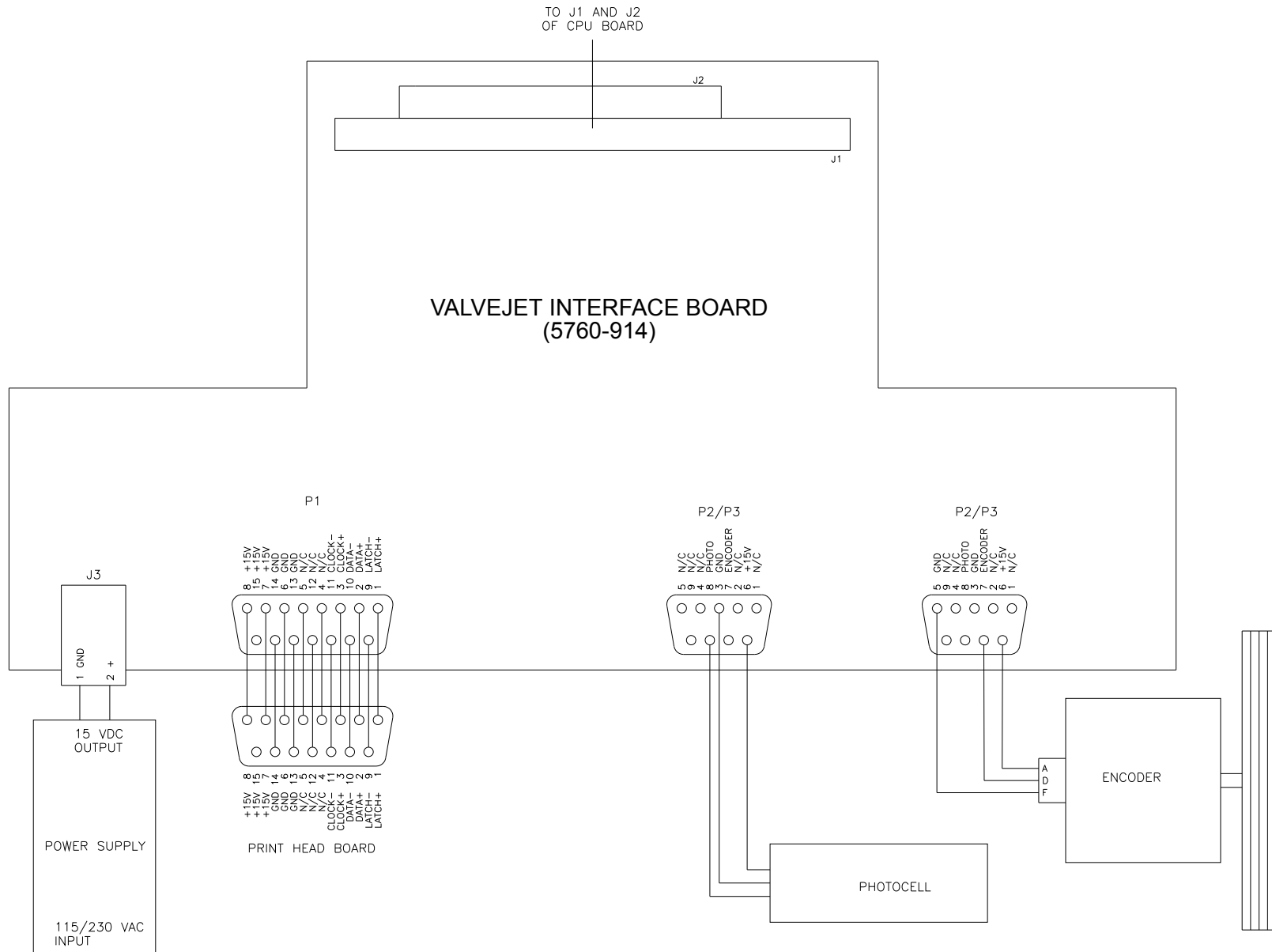

## Controller Connections



**NOTE:** The Integrated Valve Jet Interface Board requires use of the 15 VDC Power Supply.

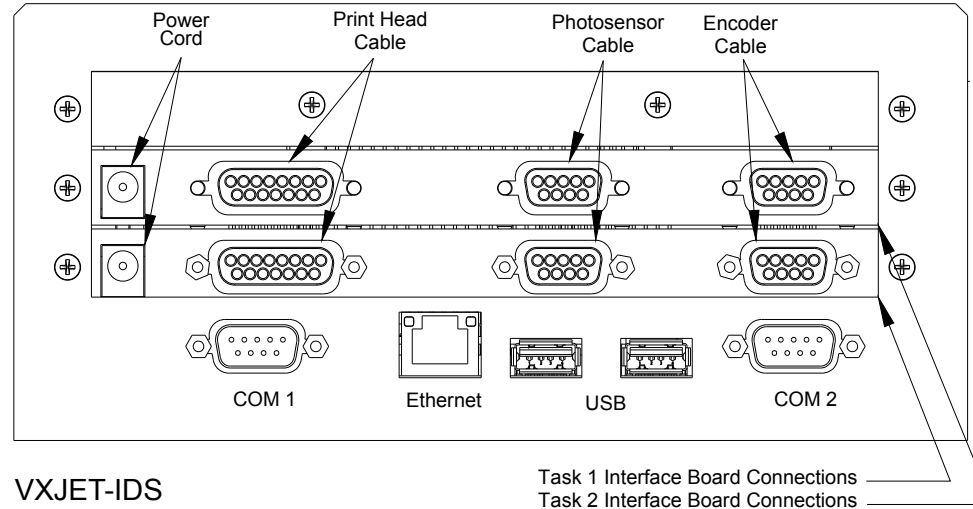

## Appendix B: Theory of Operations

The ijRemote program on the PC and the controller utilizes a graphical desktop sharing protocol to remotely control the VXJET-IDS. The program transmits keyboard and mouse events from the PC/controller to the VXJET-IDS. In turn, graphical screen updates are relayed back to the controller from the VXJET-IDS. Print head data control is maintained by the VXJET-IDS.

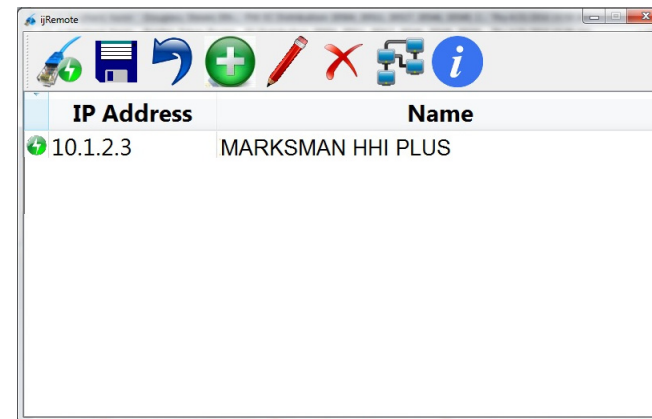
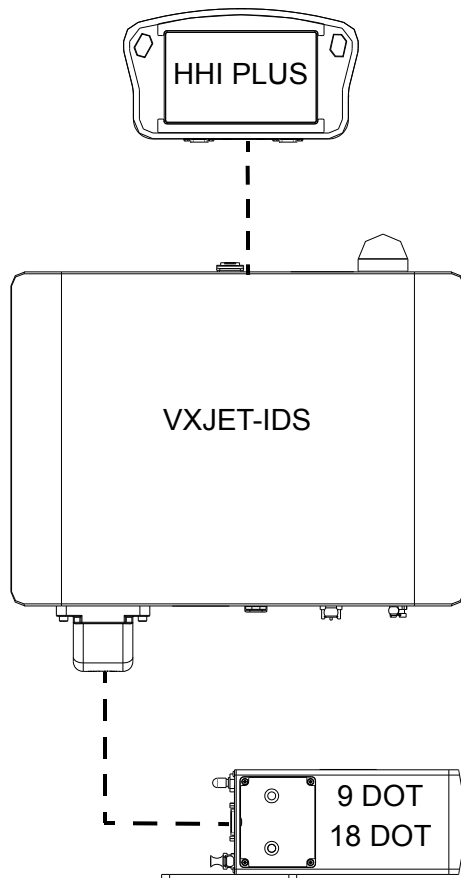

## Appendix C: File System Backup and Restore

### Backup

1. Insert a USB jump drive into the USB port on the HHI PLUS.
2. From the **Home** screen touch **Apps** then **Utilities**.
3. From the **Utilities** screen select **Backup**.
4. Enter a file name at the **Backup** dialog popup. "backup" is the default name. This creates a "backup.tgz" file.
5. From the **System Utilities** screen select **Safely remove USB memory**.

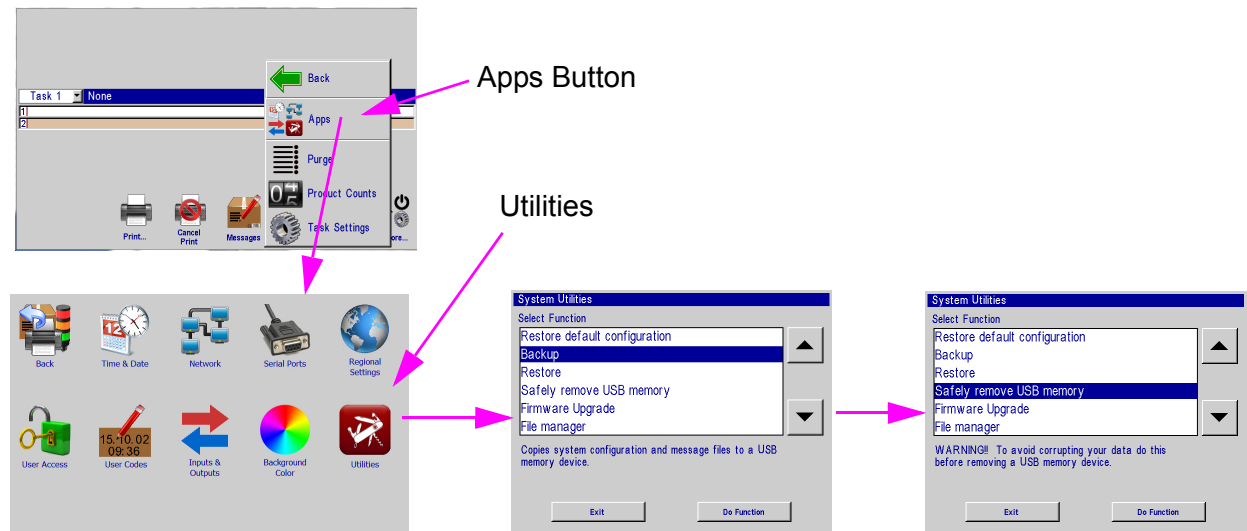

### Restore

6. Insert a USB jump drive containing a "backup.tgz" file into the USB port on the HHI PLUS.
7. From the **Home** screen touch **Apps** then **Utilities**.
8. From the **Utilities** screen select **Restore**.
9. Select the appropriate backup file from the **Restore** dialog popup.
10. From the **System Utilities** screen select **Safely remove USB memory**.

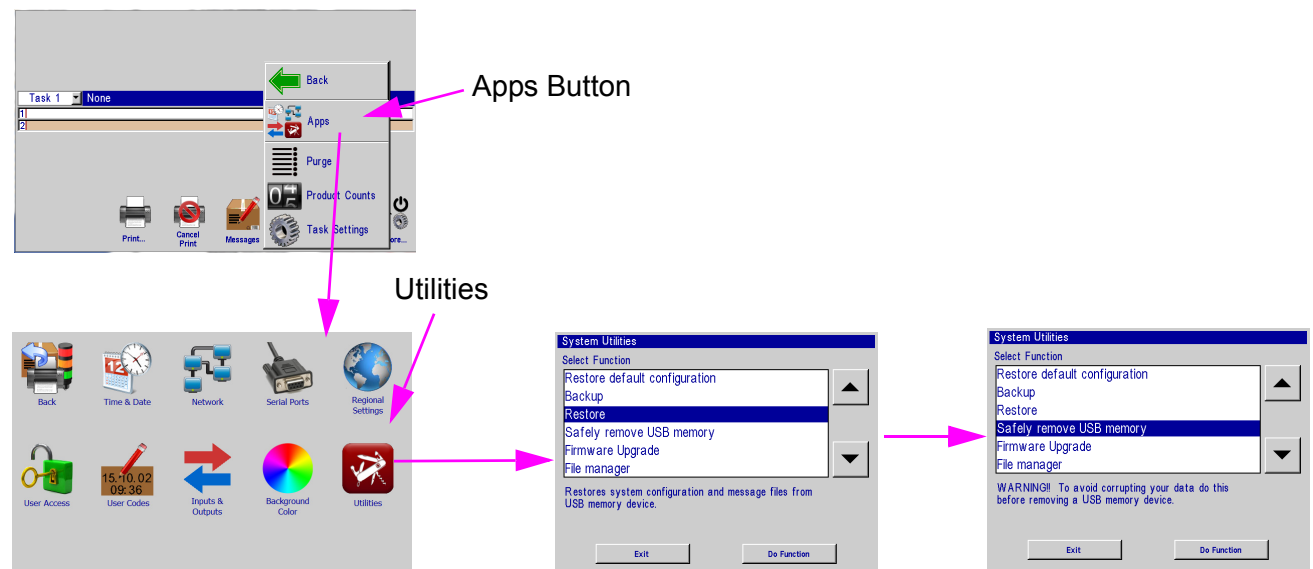

### Appendix D: Configuring a PC to Communicate with a Controller and VXJET-IDS

#### Window 7®

1. Open the **Start Menu**; select **Control Panel**; then **Network and Sharing Center**.

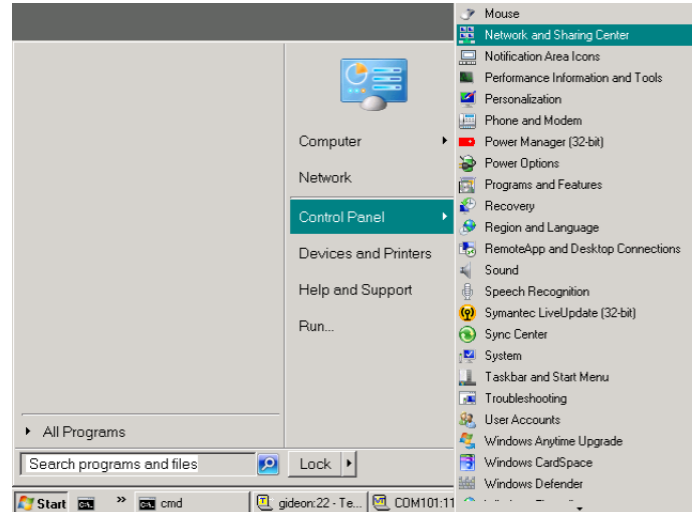

2. Click **Local Area Connection**, then click the **Properties** button.

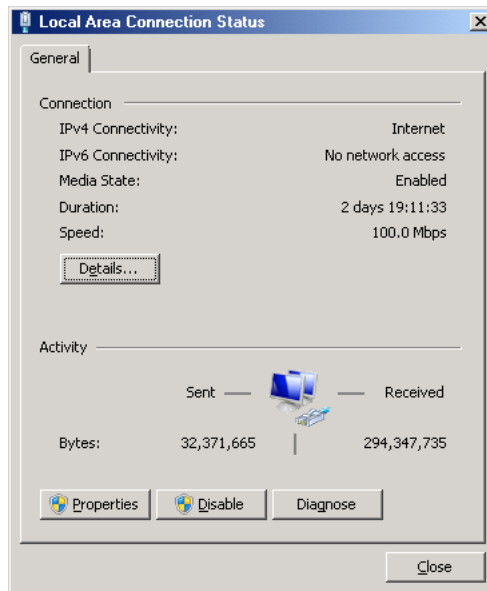
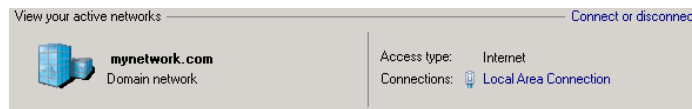

3. Select **Internet Protocol Version 4 (TCP/IPv4)**. Then click the **Properties** button.

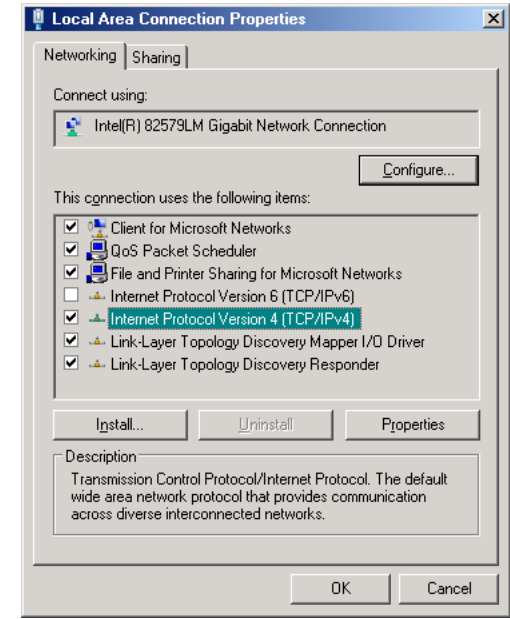

4. Click **Use the following IP address** radio button. Enter and IP address of **10.1.2.4**, a subnet mask of **255.255.255.0**, and click the **OK** button.

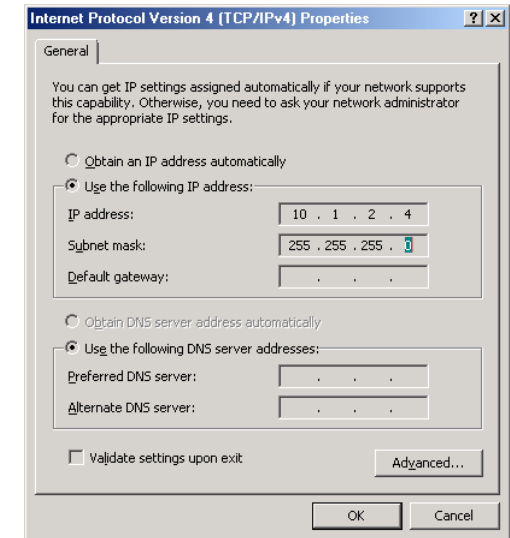

### Appendix E: Controller and Print Head File Management

#### File Manager

1. If logo or font files are to be transferred, place them on a portable USB storage device and insert it into the HHI PLUS USB port.
2. Touch the **Apps** button on the **Home** screen menu, and then select the **Utilities** button.
3. Scroll to the bottom of the **Select Function** list and select **File manager**. Press the **Do Function** button; the **File manager** screen is displayed.

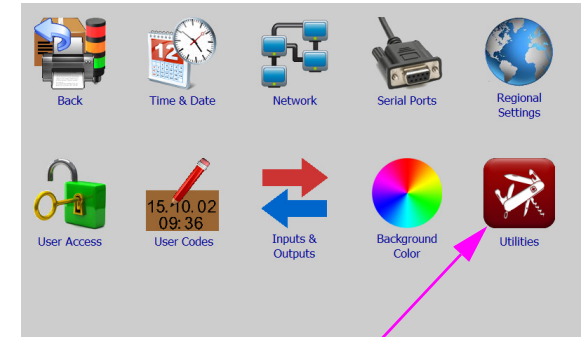
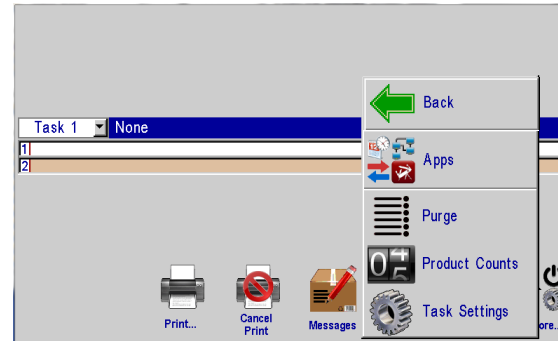

Utilities Button

The **home** folder contains all folders and files related to controller operation.

The **usb0** folder contains all folders and files resident on the USB storage device.



**NOTE: Cut, Copy, Paste, and Delete function the same way as any software. Navigate to any file in any of the folders and perform the desired function.**

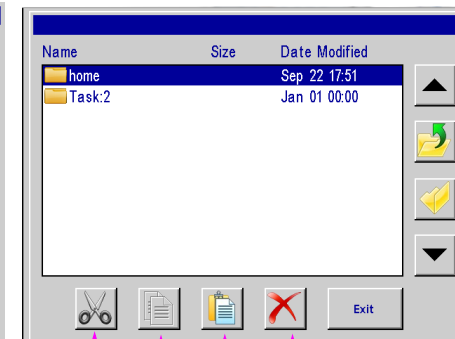
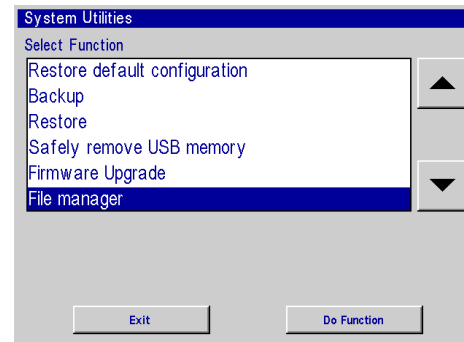

Cut Copy Paste Delete



## Appendix F: Transferring Logo and Font Files



**NOTE: Files cannot be transferred to the print head while printing. Pause print first.**

1. As shown in the “File Manager” section, make sure USB storage device is installed and the **File manager** selection screen is present on the controller.
2. Select the **usb0** folder and press the **Open Folder** icon button.
3. Navigate to a previously saved file, highlight the file and press the **Copy** button. The file is now stored in temporary memory. In this example, a logo file will be transferred.
4. Press the **Close Folder**, then the **Go Up One Level** button until the **File manager** selection screen is present.
5. Select the **home** folder, press the **Open Folder** button, and select the **bmeps** folder.

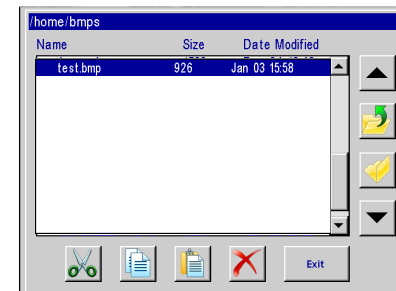
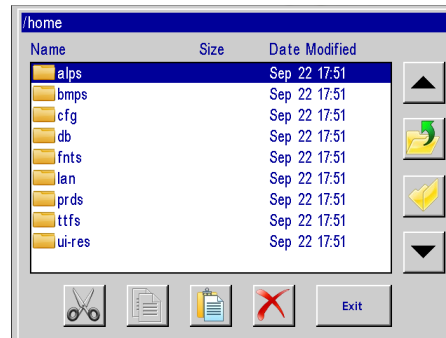

6. Press the **Paste** button. The logo (bmp) file will appear in the **bmeps** folder.
7. When all desired file transfers are complete, press the **Exit** button.
8. From the **System Utilities** menu, press the **Safely remove USB memory** button, and the **Done**.
9. The file is now available for message creation in the message editor.

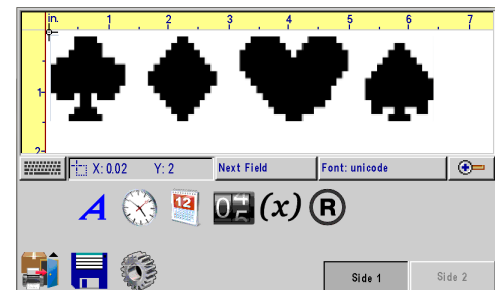
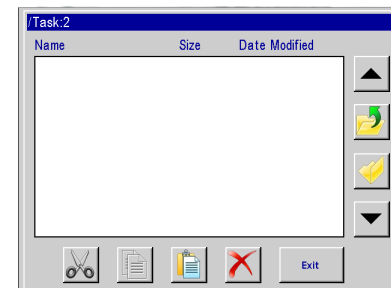

## Appendix G: ijRemote Application and Multiple VXJET-IDSs

### ijRemote Application



The ijRemote application allows the user to connect remotely from their desktop to the VXJET system located at the point of printing. An Icon will be located on your Desktop after installing the Ink Jet Demo software on your PC.



Connects to the selected VXJET-IDS.



Save any changes made to the list of VXJET-IDSs.



Undo any unsaved changes.



Adds another VXJET-IDS to the list.



Edit existing VXJET-IDS in the list.



Deletes a VXJET-IDS from the list.



Shows the current firmware version of the HHI PLUS.



Sets the Network settings of an HHI PLUS or VXJET-IDS using the device's MAC address.

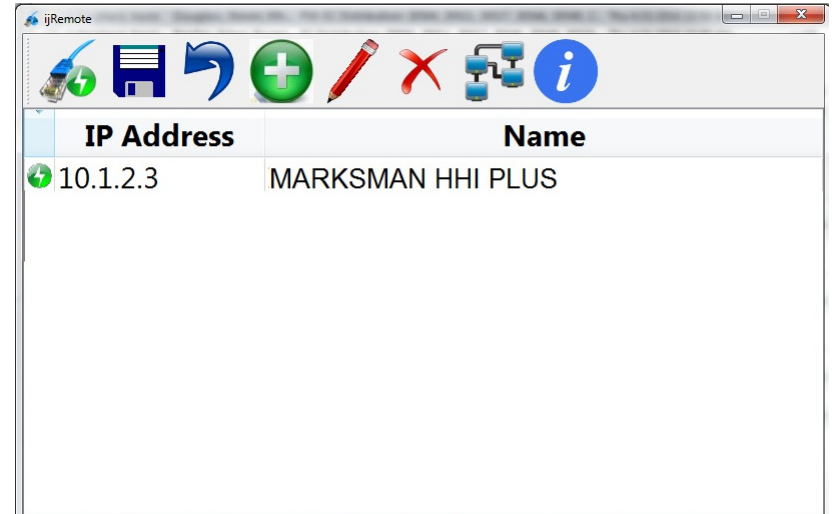

### Operating Multiple VXJET-IDSs with One Marksman HHI PLUS

This section describes how to configure a system where one HHI PLUS controls up to ten VXJET-IDSs via Ethernet.

#### What's Needed

- A PC.
- Ink Jet Demo software (on USB drive shipped with HHI PLUS).
- RJ45 CAT5E in-line crossover coupler, part number 5765-379 or equivalent.
- Marksman HHI PLUS.
- VXJET-IDS.
- An Ethernet drop for the PC, the HHI PLUS, and each VXJET-IDS.

#### Summary of Procedure

This procedure assumes all VXJET-IDSs and the HHI PLUS have their factory set IP addresses.

1. Install the Ink Jet Demo software on the PC and start the **ijRemote** application.
2. Attach a VXJET-IDS to the network.
3. Set the VXJET-IDS's IP address.
4. Add the VXJET-IDS to the ijRemote controller list.
5. Repeat steps 2, 3, and 4 for each of the remaining VXJET-IDSs.
6. Tell the HHI PLUS where to find the VXJET-IDSs

#### Procedure

1. Attach the PC to the network, and then install the Ink Jet Demo software:
  - Insert the USB flash drive that came with your system into a USB port on your computer. Open the drive, open the **Software** folder, and double-click the **demo.exe** file. An installation wizard will start, giving step by step instructions for installing the software.
  - Start the **ijRemote** application. If a desktop icon was created when the software was installed, double-click the icon. If an icon was not created, navigate to **c:\InkJet** and double-click the **ijRemote.exe** file. It may take up to 10-15 seconds for the program to initialize and begin running, after which the screen will look like the image to the right.
  - The error dialog is displayed because no VXJET-IDSs are attached to the network yet. Click **OK** to close the dialog.

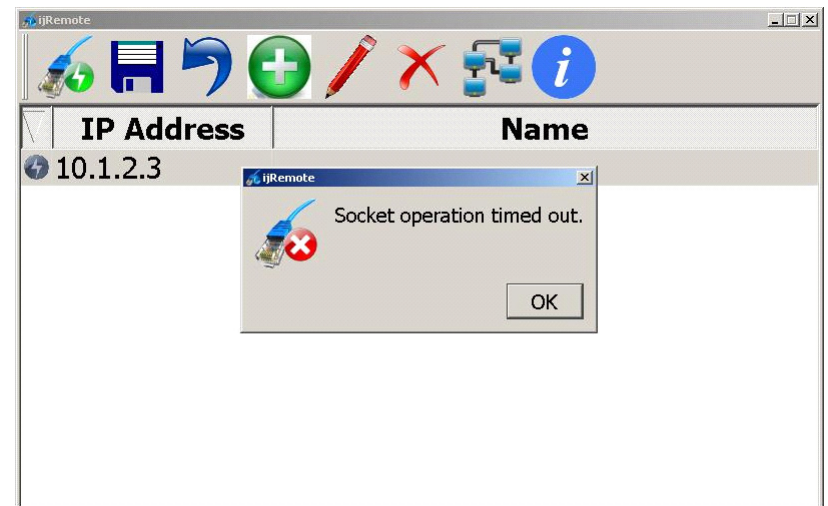

2. Attach a VXJET-IDS to the network. One Ethernet drop is required if attaching a VXJET-IDS and HMI. An Ethernet Switch (5765-461) is also required when attaching an HHI PLUS.

To connect to the network:

- A. Make sure the VXJET-IDS is turned off and unplugged from its power source.
- B. Remove the cover from the VXJET-IDS.
- C. Disconnect Ethernet cable **(A)** from CPU board and connect to Ethernet Switch **(C)**. The other end of the cable assembly plugs into the HHI PLUS.
- D. Feed a cable from an Ethernet drop **(B)** into the cabinet through its strain relief and plug it into the Ethernet Switch **(C)**.
- E. Plug one end of an Ethernet cable **(D)** into the Ethernet Switch, and the other end into the CPU Board's (bottom board) RJ45 connector.
- F. Plug the USB power cable **(E)** that runs from the Ethernet Switch into the unpopulated USB port on the CPU board.
- G. Replace the cover on the VXJET-IDS, plug it into its power source, and turn it on.

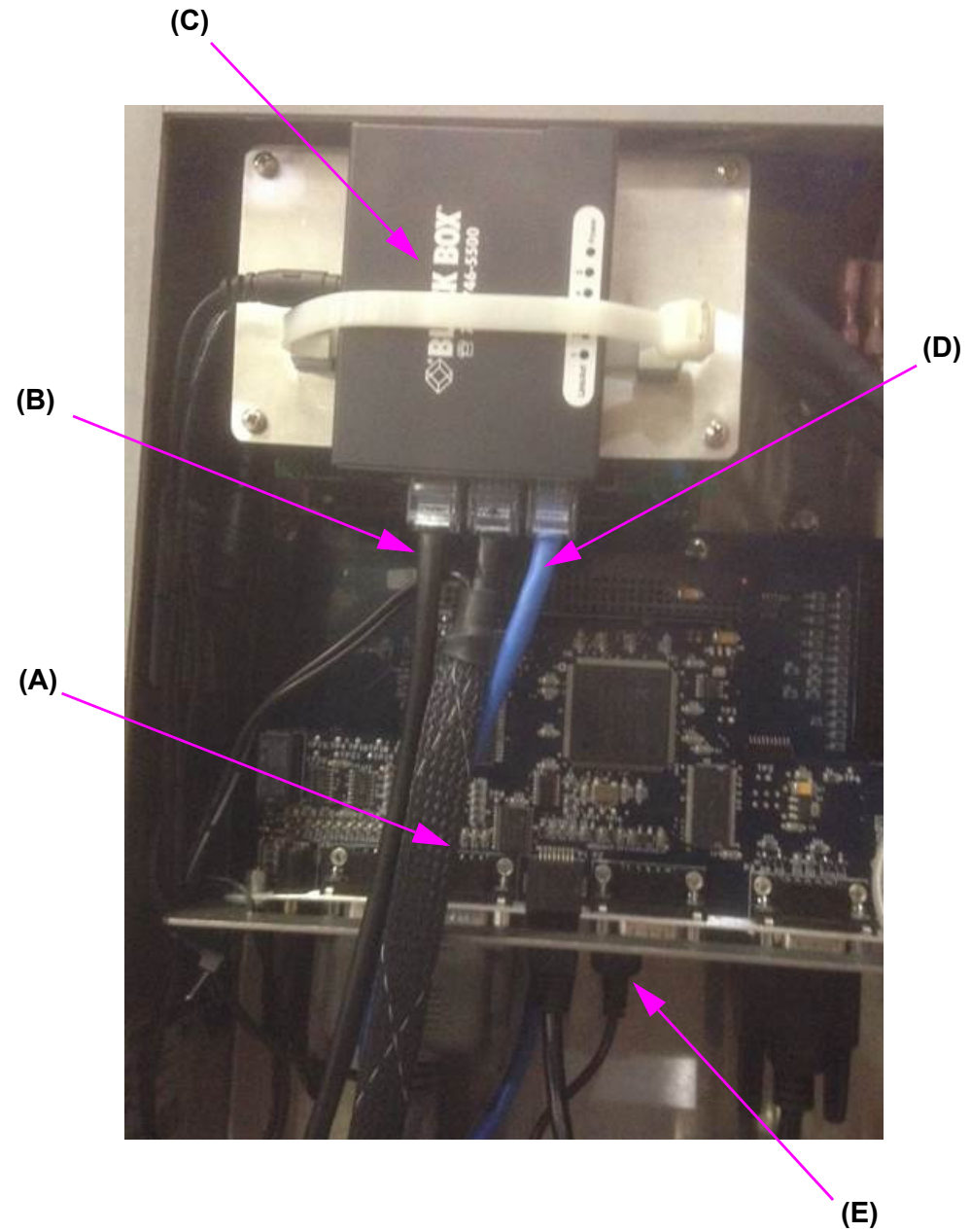

3. Set the VXJET-IDS's IP address:



- On the PC, wait for the Connected icon  to the left of IP address 10.1.2.3 to turn green (it may take a few moments), then select the VXJET-IDS and click the **Connect** button. The Home Screen of the VXJET-IDS will be shown (below left).
- Open the **More...** menu and click the **Apps** button (below right).

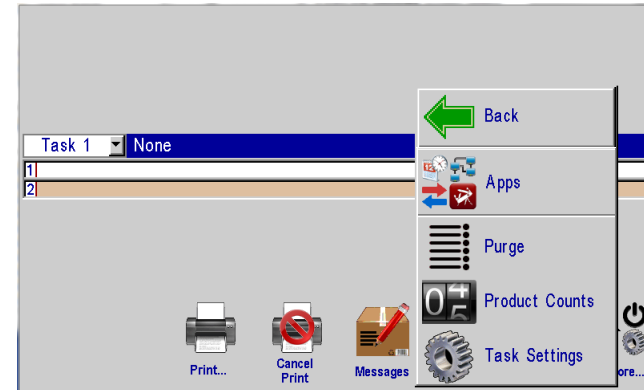
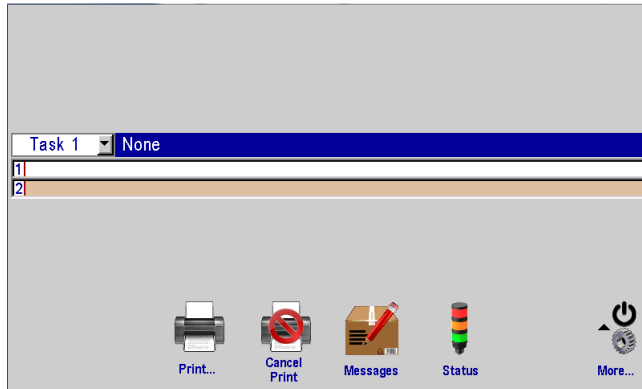

- On the **Apps** Screen (below left) touch the **Network** button to open the Network Settings Dialog (below right), and then touch the **IP Addresses** tab.

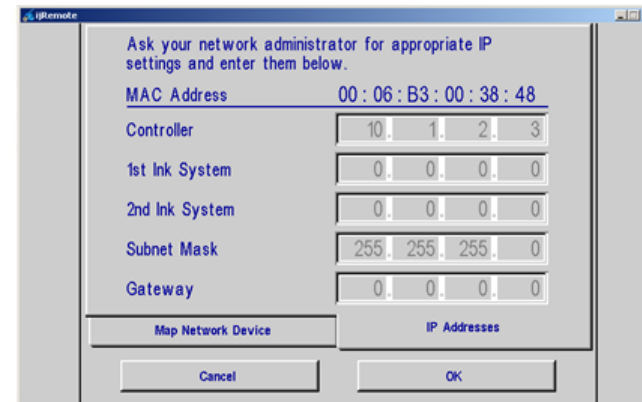

- Locate the MAC address at the top of the page and record it for later use.
- Return to the Home Screen, open the **More...** menu, and click the **Back** button to return to the ijRemote main screen.





- On the ijRemote Main Screen, click the **Network** button to open the Send Network Setting Dialog.
- Complete the **Send to MAC** line using the last two digit pairs of the previously recorded MAC address. In the case of the first VXJET-IDS of this example, it would be **38 48**.
- Enter the VXJET-IDS's desired IP address on the **VXJET-IDS** line. Do NOT use 10.1.2.3 or 10.1.2.6, which are the factory set IP addresses for the VXJET-IDS and HHI PLUS, respectively.
- The **IP Subnet Mask** is typically set to 255.255.255.0. If this is not suitable to your application, ask your network administrator for an appropriate address.
- If appropriate to your application, enter a **Gateway IP** address; otherwise leave it blank.
- When complete, the dialog will look similar to that at right.
- Click the **Send** button.

Send Network Settings

Send to MAC: 00:06:B3:00:\_\_:\_\_

HMI/Hub IP: \_\_\_\_\_.\_\_\_\_\_.\_\_\_\_\_.\_\_\_\_\_

IP Subnet Mask: \_\_\_\_\_.\_\_\_\_\_.\_\_\_\_\_.\_\_\_\_\_

Gateway IP: \_\_\_\_\_.\_\_\_\_\_.\_\_\_\_\_.\_\_\_\_\_

Send Cancel

Send Network Settings

Send to MAC: 00:06:B3:00:38:48

HMI/Hub IP: 10\_.1\_.2\_.10\_

IP Subnet Mask: 255.255.255.0\_

Gateway IP: \_\_\_\_\_.\_\_\_\_\_.\_\_\_\_\_.\_\_\_\_\_

Send Cancel

#### 4. Add the VXJET-IDS to the ijRemote controller list:

- On the ijRemote Main Screen click the **Add** button to open the Add a Host Dialog.
- Enter the VXJET-IDS's IP address (as configured in previous step).
- Enter a name for the VXJET-IDS (optional).
- Click the **OK** button. The VXJET-IDS is added to the list.

Add a Host

IP Address: 10\_.1\_.2\_.10\_

Name: 500 ml bottle line

OK Cancel

IP Address	Name
10.1.2.10	500 ml bottle line
10.1.2.3	



5. Repeat steps 2, 3, and 4 for the remaining VXJET-IDSs.



6. Click the **Save** button to save the list and generate a **vnc.cfg** file.

7. Tell the HHI PLUS where to find the VXJET-IDSs:

- On the PC, open a web browser, enter a URL of 10.1.2.6 (the HHI PLUS default IP address), and press **Return**.
- Click the **Transfer file from PC to controller** link.
- Click the **Browse...** button. When the File Upload dialog appears, navigate to **c:\InkJet\cfg**.
- Select the **vnc.cfg** file and click the **Open** button.
- Click the **upload** button.
- Reboot the HHI PLUS by cycling power to its VXJET-IDS.

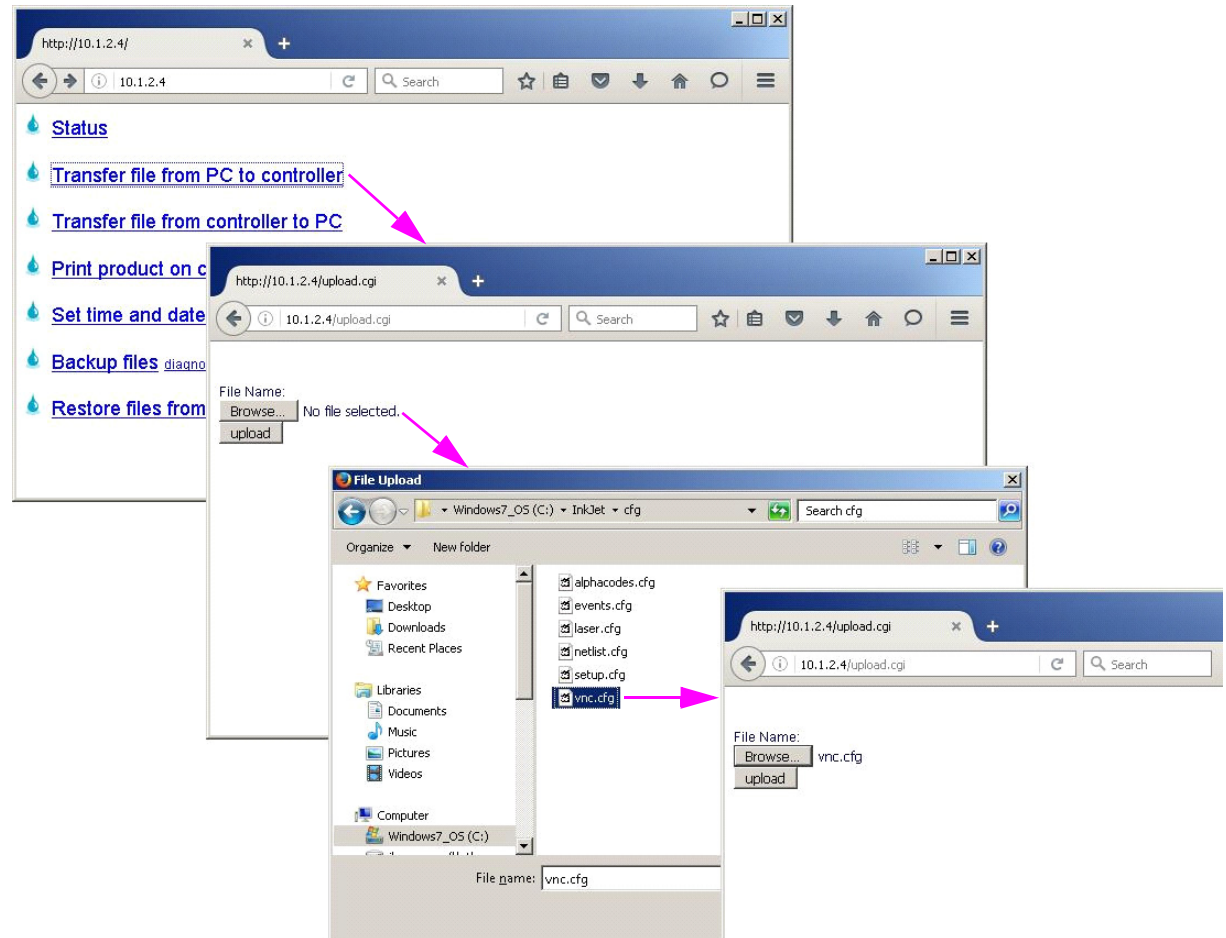

## **Appendix H: Updating the HHI PLUS & VXJET-IDS via USB or Ethernet**

For instructions on updating the controller and ink delivery system, please refer to document **5765-390N Updating the Controller and Ink Delivery System via USB or Ethernet**.

## **Appendix I: InkJet Demo Software for Windows**

For information on the InkJet Demo software, please refer to document **5765-388N InkJet Demo Software for Windows**.



## Appendix J: Part Numbers

### VXJET System

#### Major Components

Item	Kit No.	Description	Item	Kit No.	Description
1	5780-017FXV	Marksman HHI PLUS, Controller (Domestic or European)			
2	5770-016DV1PFX	VXJET-IDS, 1 Card, Porous (Domestic)	10	5770-016DV1P-SFX	VXJET-IDS, 1 Card, I/O, Porous (Domestic)
3	5770-016DV1NFX	VXJET-IDS, 1 Card, Non-Porous (Domestic)	11	5770-016DV1N-SFX	VXJET-IDS, 1 Card, I/O, Non-Porous (Domestic)
4	5770-016EV1PFX	VXJET-IDS, 1 Card, Porous, (European)	12	5770-016EV1P-SFX	VXJET-IDS, 1 Card, I/O, Porous, (European)
5	5770-016EV1NFX	VXJET-IDS, 1 Cards, Non-Porous (European)	13	5770-016EV1N-SFX	VXJET-IDS, 1 Cards, I/O, Non-Porous (European)
6	5770-016DV2PFX	VXJET-IDS, 2 Cards, Porous (Domestic)	14	5770-016DV2P-SFX	VXJET-IDS, 2 Cards, I/O, Porous (Domestic)
7	5770-016DV2NFX	VXJET-IDS, 2 Cards, Non-Porous (Domestic)	15	5770-016DV2N-SFX	VXJET-IDS, 2 Cards, I/O, Non-Porous (Domestic)
8	5770-016EV2PFX	VXJET-IDS, 2 Cards, Porous (European)	16	5770-016EV2P-SFX	VXJET-IDS, 2 Cards, I/O, Porous (European)
9	5770-016EV2NFX	VXJET-IDS, 2 Cards, Non-Porous (European)	17	5770-016EV2N-SFX	VXJET-IDS, 2 Cards, I/O, Non-Porous (European)

①

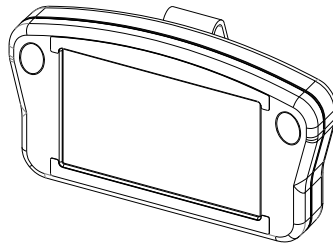

②-17

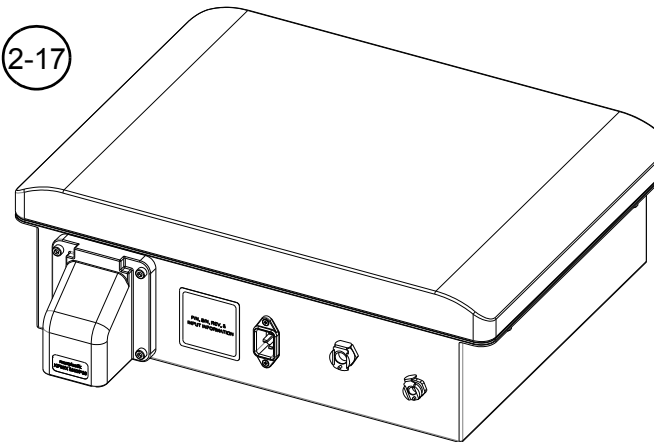

## Service Parts

### Print Head Cables

Kit No.	Description	Kit No.	Description
5700-245-002	Cable, Print Head, 2'	2464-182-010	Kit, Extension Cable, DB9, 10'
5700-245-010	Cable, Print Head, 10'	2464-182-025	Kit, Extension Cable, DB9, 25'
5700-245-025	Cable, Print Head, 25'		



### Display, Power Supply and PCBs

Item	Kit No.	Description	Item	Kit No.	Description
1	5780-232	Kit, Replacement Display, Handheld	9	5770-247	Kit, Internal Tubing & Fitting Replacement
2	5765-228	Kit, Replacement, CPU, HHI PLUS	10	5770-234P	Kit, Fluid Capacitor Replacement, Porous
3	5760-304	Kit, Replacement, Integrated Valve Interface Board		5770-234NP	Kit, Fluid Capacitor Replacement, Non-Porous
4	5760-392	Kit, I/O Board	11	5770-529	Kit, Transformer, Ink Supply
5	5770-253	Kit, Replacement, Power Supply, VXJET-IDS	12	5770-246	Kit, PCB Replacement, Ink Supply
6	5770-252	Kit, Beacon Replacement, 3-Color	13	5760-338	Kit, Power Supply Replacement, 12V
7	5765-381	Kit, Replacement, CPU, VXJET-IDS	14	5765-461	Kit, Switch, USB
8	5760-315	Kit, Pump & Thermal Cut-Off, 115 VAC	(not shown)	5770-260	Kit, Interface Board Upgrade, IV (includes Power Supply, Interface Board and Cables)

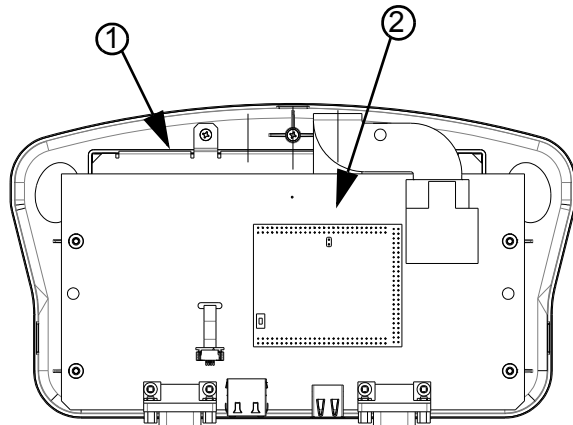

Marksman HHI PLUS

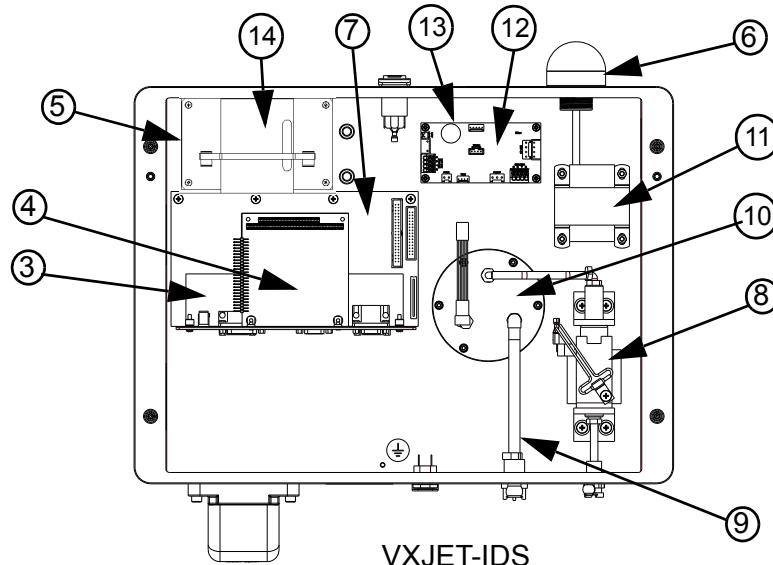

VXJET-IDS