

Operations Manual

MCA 7 Controller



404012FX
Revision A

MCA 7 Controller Operations Manual

**404012FX
Revision A**

The information contained in this manual is correct and accurate at the time of its publication. The manufacturer reserves the right to change or alter any information or technical specifications at any time and without notice.

©2019 Illinois Tool Works Inc.

All rights reserved

MCA 7 Controller

Warranty:

The MCA 7 controller, including all components unless otherwise specified, carries a limited warranty.

For all warranty terms and conditions, contact the manufacturer for a complete copy of the Limited Warranty Statement.

MCA 7 Controller

Section 1: Safety	3
Section 2: Basic User Interface	4
Home Screen	4
Information Menu	5
Job Menu	6
Label Menu	7
Setup Menu	8
Section 3: Application Specific Menus	12
System Menu & Actuator Setup Menu	12
Section 4: Advanced Menus	13
Discrete I/O Menu	13
Network Menu	14
Link Menu	15
Connection Menu	16
Section 5: Trouble-Shooting	17
Information, Warning, Error, and Diagnostic Codes	17
Section 6: User Interface How To Guide	19
Appendix A: Specifications	21
Technical Specifications	21
Interconnection Diagram	22
Electrical Interfacing	23
Theory of Operations	24
Appendix B: Configuring a Discrete I/O Module	25
Navigation, Electrical Input & Output Characteristics	25
I/O Input & Output Events	26
Interfacing I/O Inputs & Outputs	27

MCA 7 Controller

Appendix C: Product Detector	28
Appendix D: Create the Label Format	29
Create the label format	29
Recall Label Formats from USB Drive	30
Recall Label Formats with Scanner (Optional)	31
Appendix E: Communicating to MCA	32
Appendix F: Redundant System	33
Appendix G: MCA Remote Controller	35
Appendix H: Part Numbers	36
System	36
Replacement Kits	36
Optional Equipment	37

Section 1: Safety

Following is a list of safety symbols and their meanings, which are found throughout this manual. Pay attention to these symbols where they appear in the manual.



Caution or Warning! Denotes possible personal injury and/or damage to the equipment.



Caution or Warning! Denotes possible personal injury and/or equipment damage due to electrical hazard.



NOTE: (Will be followed by a brief comment or explanation.)



ESD protection should be worn when servicing internal printed circuit boards.

After service to the equipment is completed, replace all protective devices such as grounding cables and covers before operating the equipment.

WARNINGS

- WARNING - Moving parts of this machine can present hazards. Components that cannot be guarded because of loss of functionality are marked with a warning symbol.
- Be aware of the actuator extension distance, and avoid accidental triggering of the photosensor.
- When servicing the unit's electronic assemblies, always remove the power cord from the unit to prevent accidental shock.
- When running for extended periods of time, use caution when accessing the drive module circuitry. The motor drive power transistors, motor case, and motor heatsink can become hot under constant use.
- Wear personal protective equipment, as instructed by your supervisor, when operating or working near this device.

Section 2: Basic User Interface



Home Screen

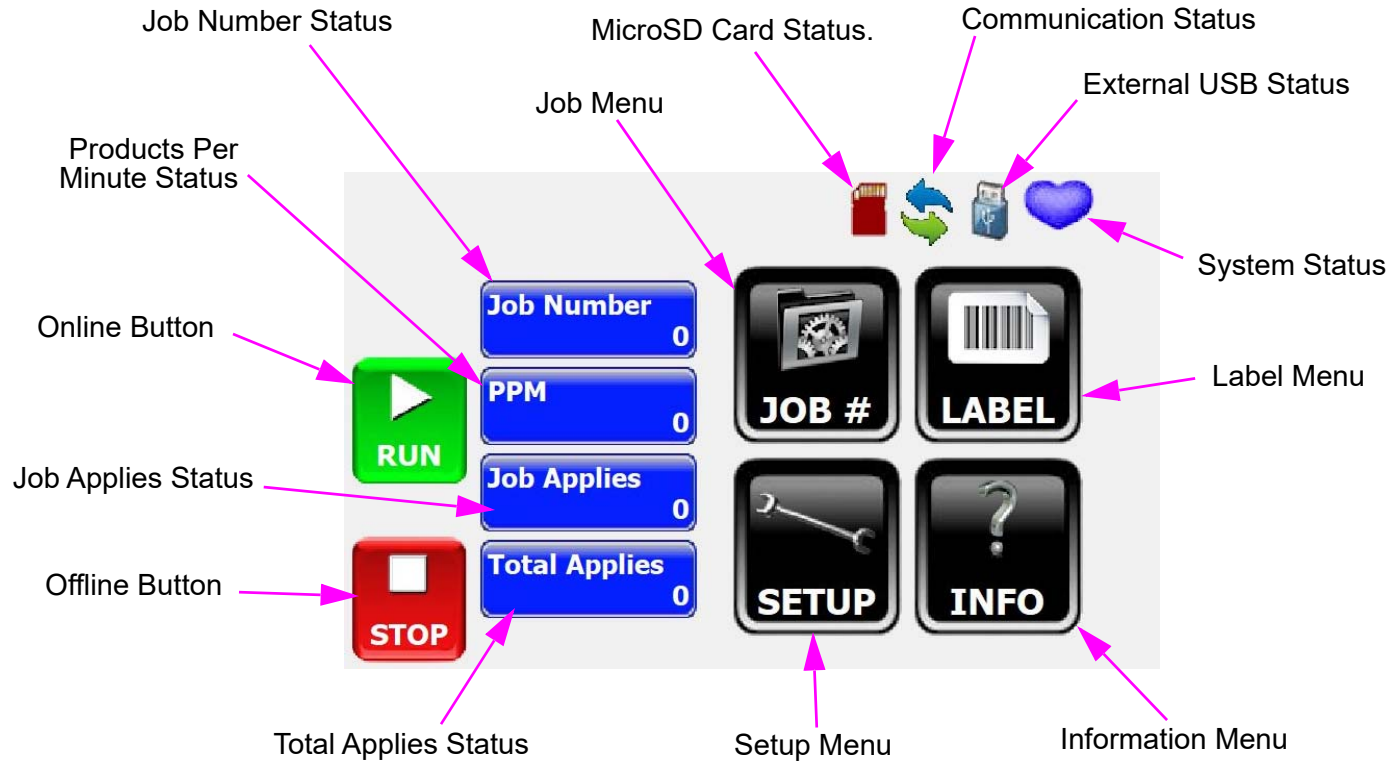

Any changes made to the settings are permanently saved when the **Home** button is pressed. Otherwise, the settings will be temporary.



Information Menu

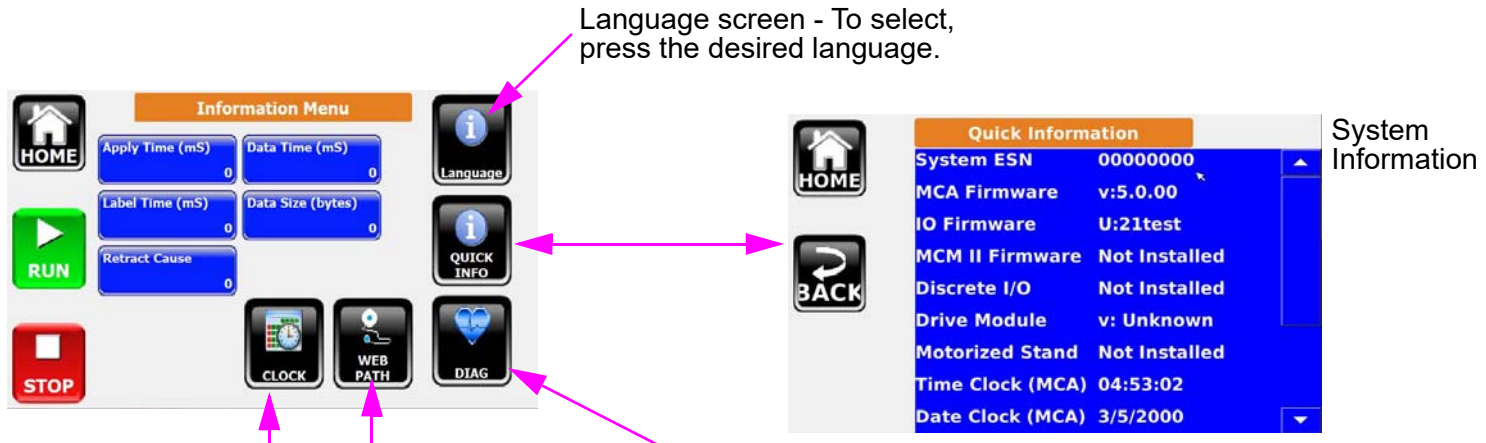

Select icons to set Date and Time.

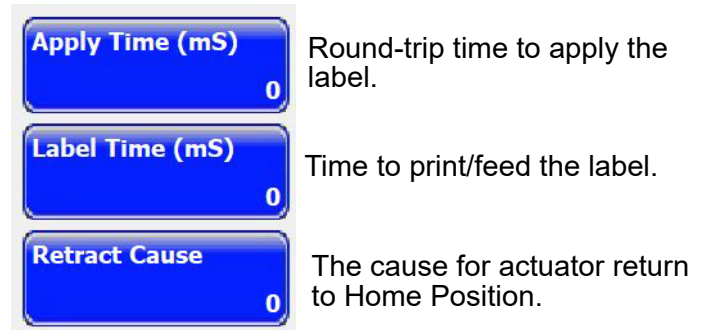
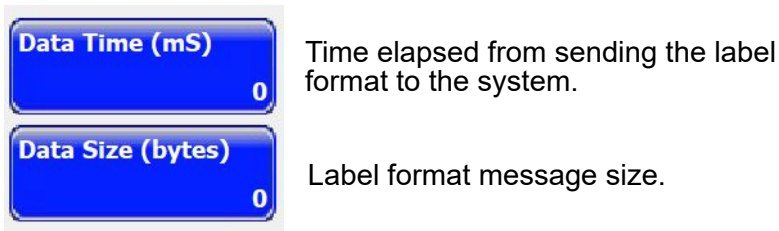



Job Menu



Recall a job by using the up/down arrows or Job button.

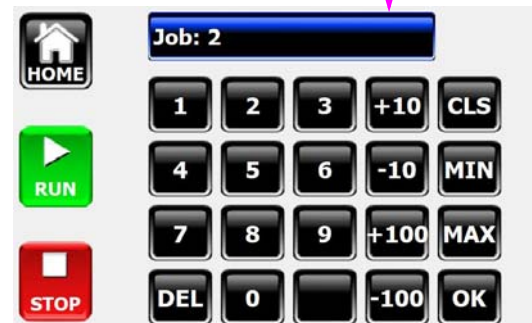

The job will be recalled when returning to the Home Screen.



Label Menu

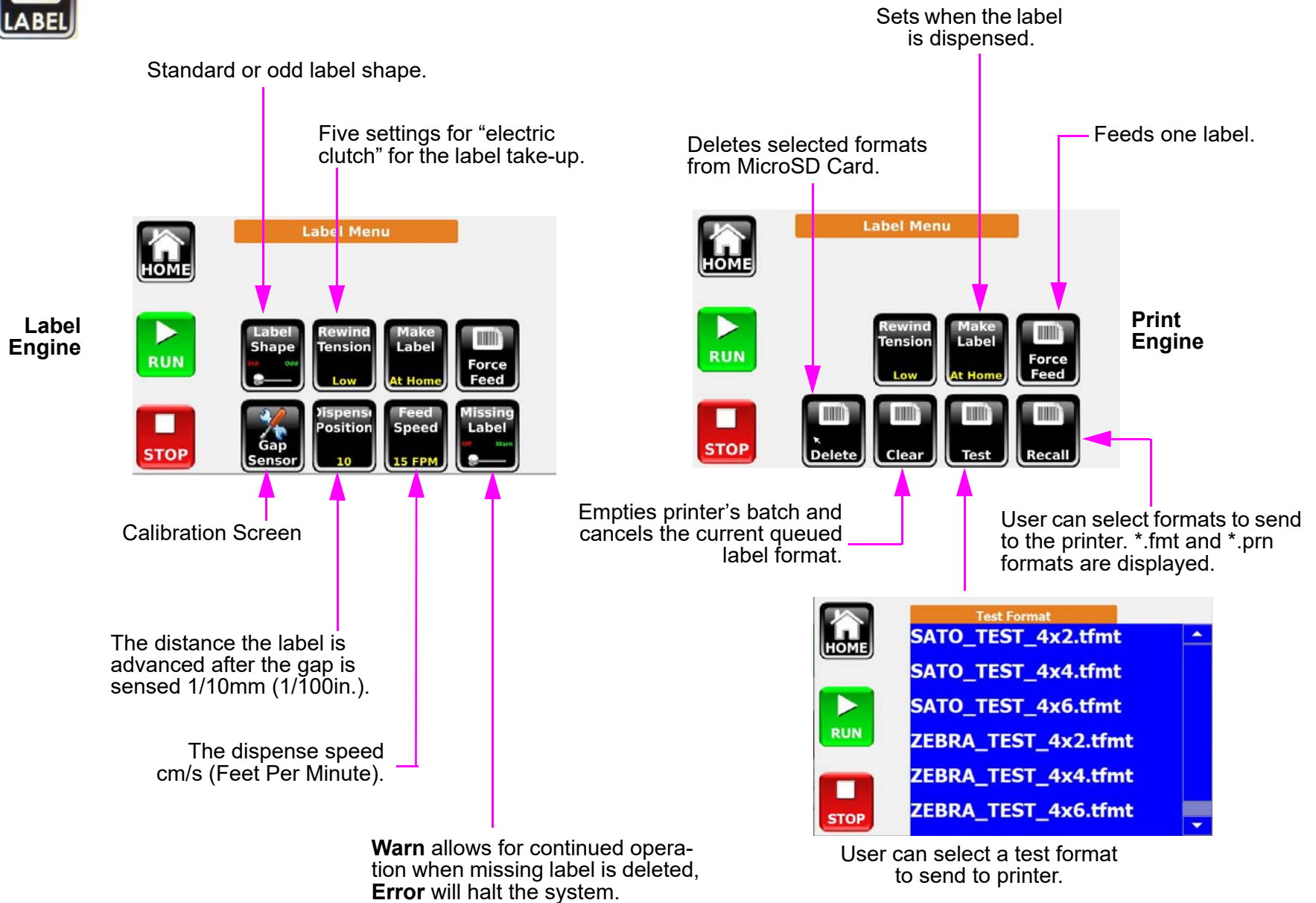



Setup Menu



Pressing the power button will do a soft power off. When the system shuts down it can be awakened by pressing anywhere on the display.



Pressing the disconnect button will disconnect from UI and go to Connection Menu.



File Menu

Connect the USB stick to the back of the MCA and press the **FILES** Button from Setup Menu to access Files Menu.

Returns to Home Screen and saves settings.

Sets file transaction direction from system to USB or from USB to system.

Downloads MCM II firmware. It will be visible if MCM II firmware is downloaded in the root directory of the USB.

Downloads MCA firmware. It will be visible if MCA firmware is downloaded in the root directory of the USB.

Transfers system settings to the microSD card or USB.

Downloads U2 chip firmware. It will be visible if U2 firmware is downloaded in the root directory of the USB.

Transfers all files to the microSD card or USB.

Transfers formats to the microSD card or USB.

Smart Menu

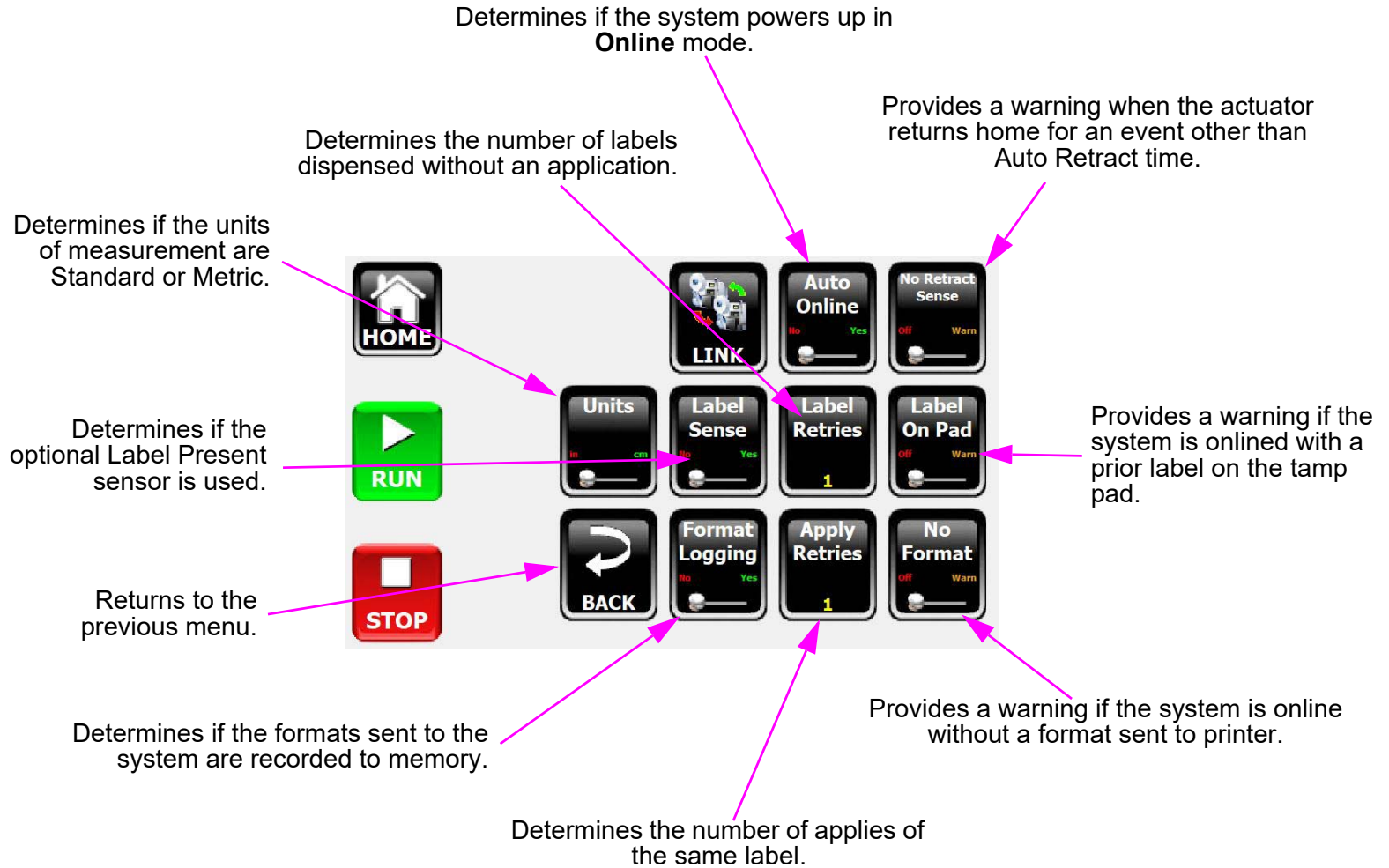



System Menu

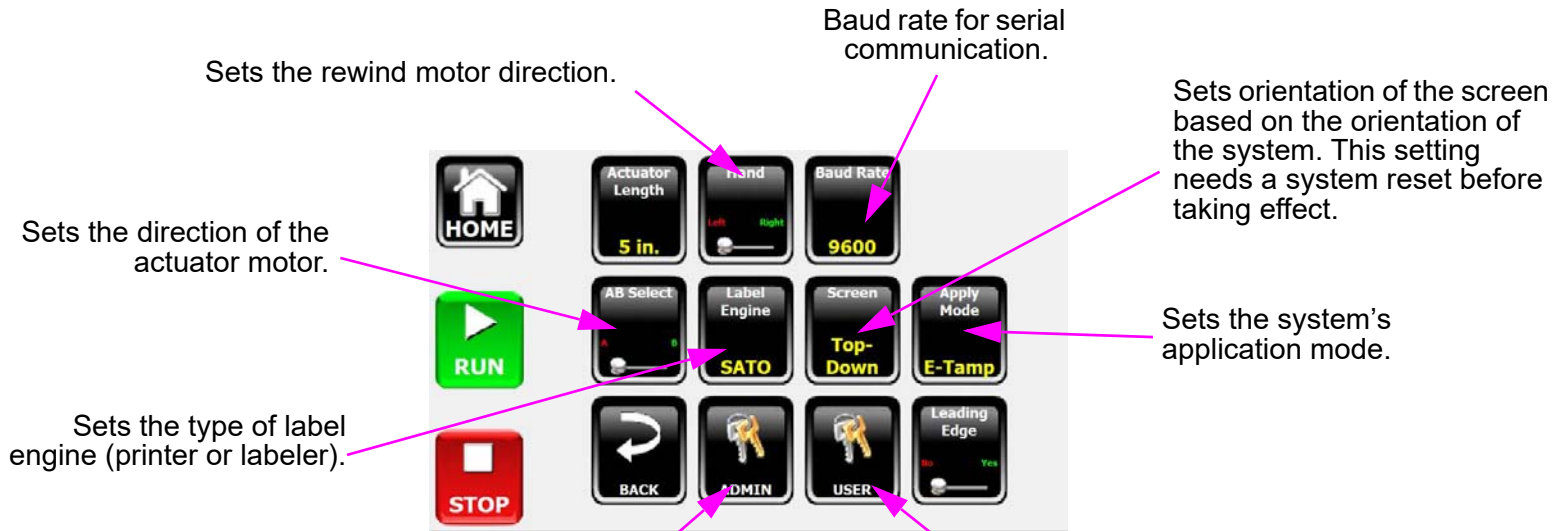

Sets the Admin Passcode. The passcode can be set to up to 8 digits. If Admin passcode is set to 0 all the menus will be unprotected.



Can be set to up to 8 digits. If User Passcode is set to 0 the menus with user protection will be unprotected.

Passcode

The factory default passcode is 0, which can be individually set for Administrator and User access levels. Administrator access allows for changes to all settings and parameters, while the user access allows for Job parameter changes. Run/stop operation and Informational Menus are not passcode protected.

Note: Other menus in the Setup Menu will be dependent on the application or considered advanced and will be discussed in the next two chapters.



Job Menu



Sets the E-Tamp Blow mode. **No** (no blow), **Sensor** (blow on Auto Retract sensor), and **Retract** (blow when retracting).

Sets the current job. Each job contains different settings.

Actuator Setup Menu

Time between the actuator returning home and the next label printed/fed.

Determines if the system will apply one or two labels for each product trigger.

The delay between Auto Retract sensor detects the product and actuator retracts, to allow additional time to contact the product.

2nd Auto Retract delay (only if Applies Per Trig is 2).

Sets 2nd apply delay. It must be greater than one full apply cycle + label print time.

2nd Apply Duration time (only if Applies Per Trig is 2).

The delay between product detector trigger and application start. Adjust value to change label placement on product.

The time the actuator goes back to Home position after it extended.



Note: Job settings can be made while the system is operating. However, values are preloaded before the product detector is triggered. Therefore, it will take two application cycles to observe a setting change. Going offline, then online forces the change to take effect on the next application cycle.

Section 3: Application Specific Menus

System Menu & Actuator Setup Menu

Length of the actuator. Available options 12, 25, 38/50 and 64/76cm (5, 10, 15/20, and 25/30").

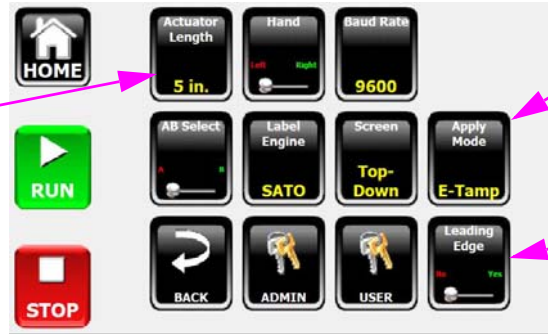

E-Tamp, E-FASA, Wipe, E-WASA, Blow Box, HS-Tamp and E-WASA+

Yes - offsets the label placement from the front edge.
No - from the trailing edge of the product.

Below Applies to E-Tamp, HS-Tamp and E-FASA Apply Modes.

The furthest extension of the tamp with 1cm (1") increments.

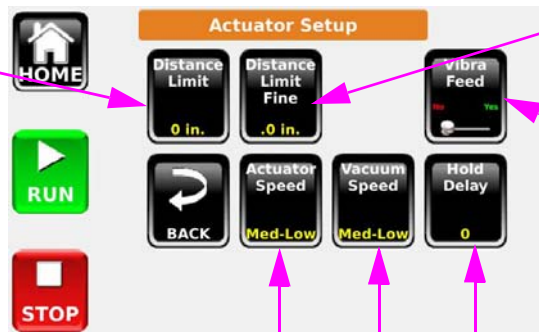

The furthest extension of the tamp with 6mm (1/4") increments.

If enabled the pad vibrates during label print/feed to help thicker labels or with stronger adhesive feed onto the pad properly.

The overall speed of the actuator with five discrete values.

Sets the time the actuator should hold position once it reaches the first of these conditions:

- Apply Duration expires
- Auto Retract sense
- Distance/Angle Limit Threshold reached

The Vacuum fan speed with five discrete values for different label sizes.



The furthest swing angle for E-FASA application instead of Distance Limit.

Section 4: Advanced Menus

Discrete I/O Menu

Discrete I/O is optional equipment to provide optically-isolated input and outputs. Discrete I/O Menu will be available if the device is installed. For more information see “Appendix B: Configuring a Discrete I/O Module”.

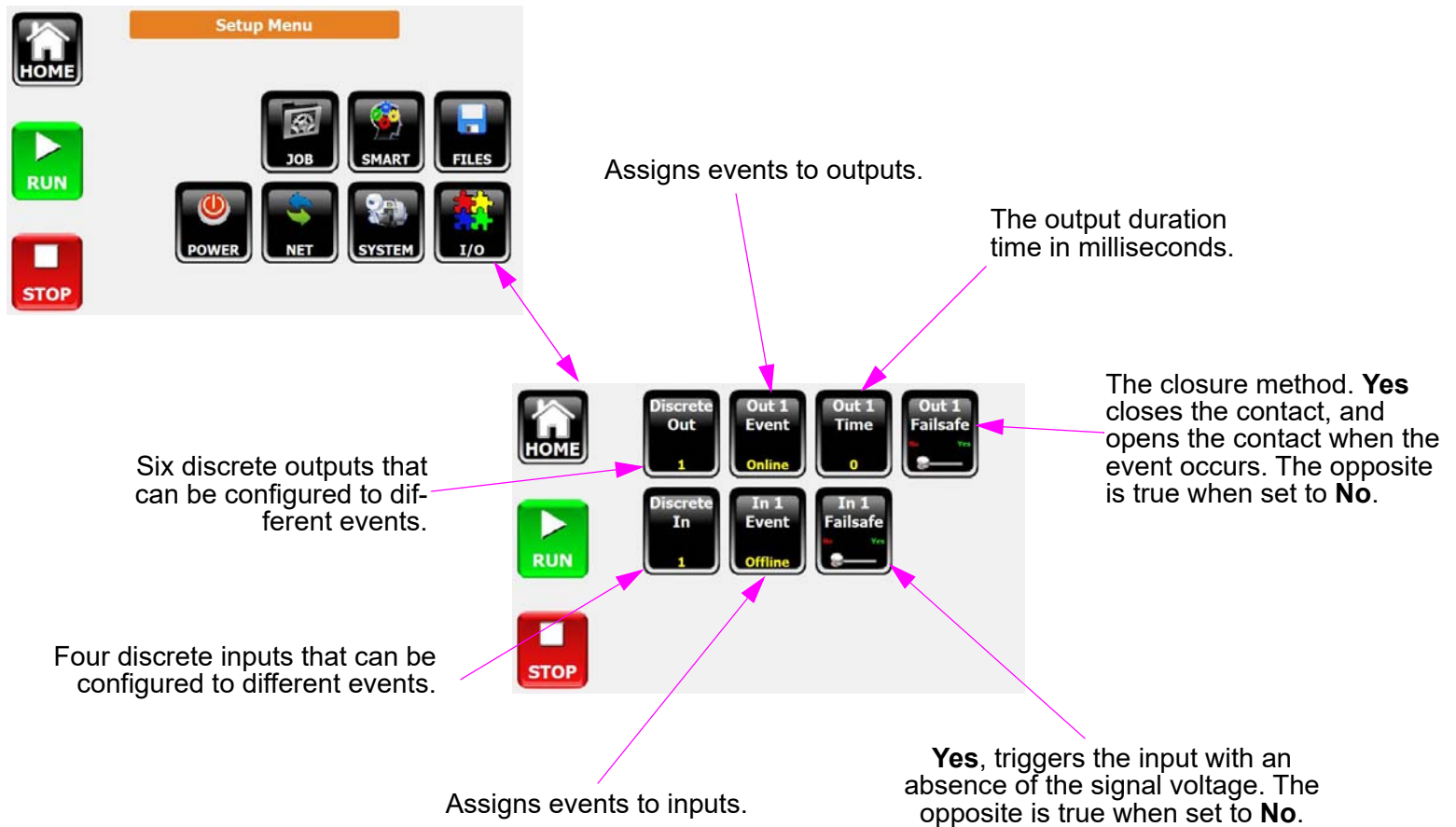

Network Menu



Shows the status of the ping being sent.

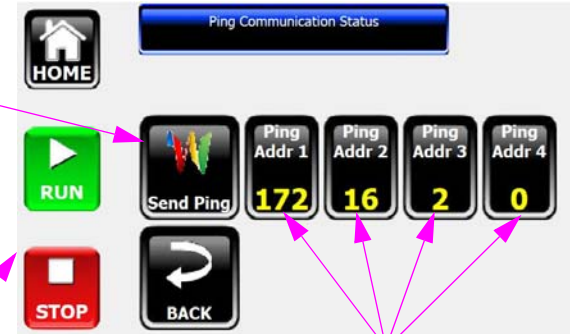

Sends Pings to the address set by Ping Address.

Sets the four octets of IP Addresses of the device being Pinged.

Opens the Ping Screen.

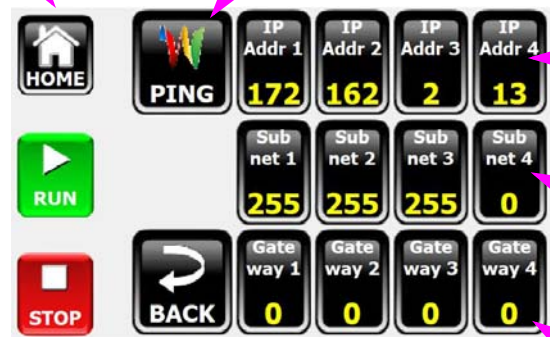

Sets the four octets of system IP Addresses from 0 to 255.

Sets the four octets of system Subnet Addresses from 0 to 255.

Sets the four octets of system Gateway Addresses from 0 to 255.

Link Menu

Link mode is available for operation between two systems. The link is established through wired Ethernet connection. From **Setup** Menu enter the **Smart** Menu to access **Link** Menu. For more information see “Appendix F: Redundant System”.

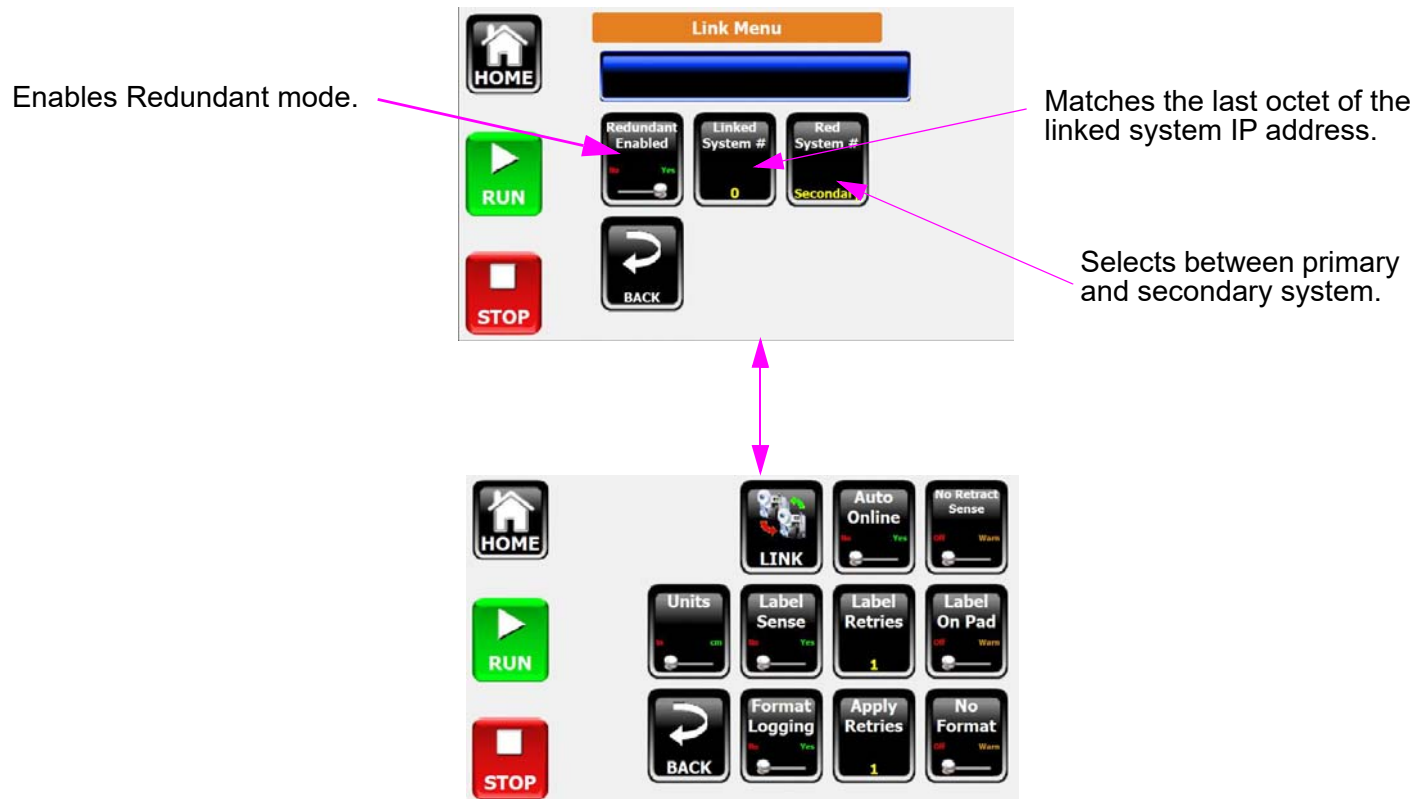

Connection Menu

System Utilities:

- Select **Calibrate Touch Screen**, then **Do Function** to enter Touch Screen Calibration screen.
- Select **Safely Remove USB Memory**, then **Do Function** to safely remove USB flash drive.

Info:

Provides information about the system: Firmware Version and MAC, IP, Subnet Mask and Gateway address.

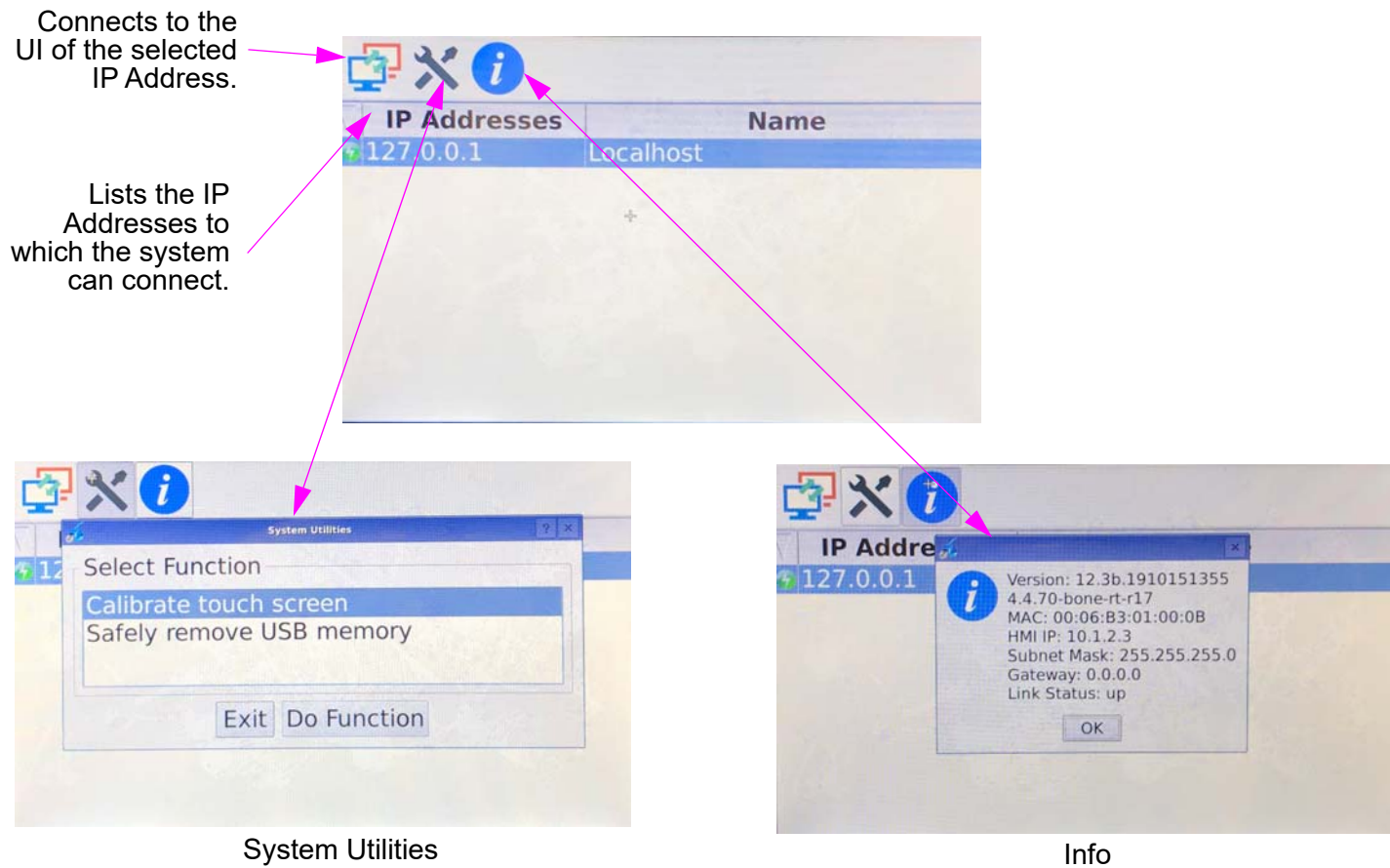



Section 5: Trouble-Shooting



Information, Warning, Error, and Diagnostic Codes

Message Number	Type	Message	Reason(s)
MSG 1	Error	ACTUATOR NOT HOME	1. Product Delay expired, but not home. 2. Actuator commanded to return home, but after 5 seconds has not returned. 3. Going online, but not home.
MSG 2	Error	ACTUATOR AT HOME	Actuator commanded to return home, but it never left home.
MSG 3	Error	APPLICATION MODULE	MCM II Module has an error.
MSG 4	Informational	AUTO RETRACT SENSOR	Upon extending the actuator, the Auto Retract is already detecting.
MSG 5	Warning	LABEL LOW	Label Low sensor sees breaks in the signal from the unwind disk and the labels depleting.
MSG 6	Error	LABEL OUT	Printer has detected the end of the label supply.
MSG 7	Warning	RIBBON LOW	Printer reports the ribbon is at the low level.
MSG 8	Error	RIBBON OUT	Printer reports the ribbon is depleted.
MSG 9	Informational	MISSING LABEL DETECT	Label Applicator has detected a missing label.
MSG 10	Error	LABEL MODULE	Label Applicator has an error.
MSG 11	Error	PRINT ENGINE	Printer reports an error condition.
MSG 12	Informational	NO FORMAT	Printer End of Print signal will not toggle, indicating the label has not started printing.
MSG 13	Informational	NO USB DRIVE	The MCA does not detect a Mass Storage Device in the USB slot.
MSG 14	Warning	NO MicroSD CARD	The MCA does not detect a microSD card in the internal connector.
MSG 15	Error	LABEL NOT APPLIED	The repeat apply threshold was exceeded.
MSG 16	Error	REPEAT LABEL REQUEST	The repeat label threshold was exceeded.
MSG 17	Error	REWIND TAKE-UP	The rewind detected a freewheel spin during online take up of the liner.
MSG 18	Error	SECOND APPLY ERROR	In a dual apply mode, the first application was not complete before the Second Apply Delay expired. Can't apply second label since the placement would be random. Increase the 2nd Apply Delay.
MSG 19	Warning	SYSTEM NOT READY	System was triggered to apply, but the label was not available to apply. Usually due to demand mode printing not allowing enough time to print or product trigger and no label format in the printer.
MSG 20	Informational	IO CONTROLLER FAILURE	U2 in the MCA Is not responding to communication.
MSG 21	Informational	E-STOP	E-Stop previously occurred.
MSG 22	Informational	PASSCODE ERROR	Incorrect passcode entered.
MSG 23	Informational	PASSCODE LEVEL	Incorrect passcode for that level.
MSG 24	Error	REWIND MOTOR FAULT	Motor driver IC reports one or more issues: 1. Disconnected cables 2. Incorrect cable pinout 3. Stalled motor
MSG 25	Informational	POWER CYCLE	Indicates the system will require a soft or hard reset to have settings take effect.

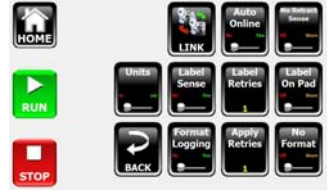
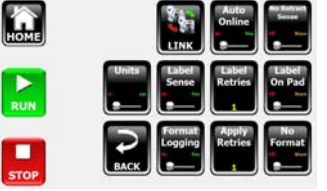
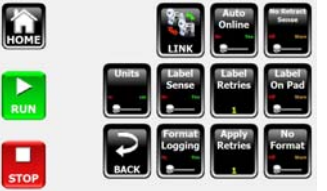
Message Number	Type	Message	Reason(s)
MSG 26	Warning	LABEL ON PAD	System detects a label on the pad when going online
MSG 27	Informational	TOTAL COUNT/TIME	These values are non-resettable, so pressing them will display this message.
MSG 28	Informational	JOB COUNT/TIME	These values can be cleared, but only in the Job Number menu.
MSG 29	Informational	OUTPUT TEST	The output diagnostic tests can only be performed when the system is offline.
MSG 30	Informational	FORMAT ISSUE	The format sent to the printer contains control codes that can impact the interface of the labeler and the printer.
MSG 31	Informational	NVMEM Cleared	The system's non-volatile memory has been erased by the user.
MSG 32	Informational	FILE(S) NOT FOUND	System files are not found on the internal microSD card. Affects part number and web path views, as a minimum.
MSG 33	Warning	DISCRETE IN WARNING	One or more of the discrete inputs assigned to warning has been triggered.
MSG 34	Error	DISCRETE IN ERROR	One or more of the discrete inputs assigned to error has been triggered.
MSG 35	Informational	NO RETRACT SENSE	Actuator returned home for a reason other than the auto-retract sensor seeing the product.
MSG 36	Informational	GAP SENSOR CALIBRATION	Instructions on how to calibrate the label gap sensor located on the peel tip.
MSG 37	Informational	CALIBRATION SUCCESS	Label gap sensor was properly calibrated.
MSG 38	Informational	CALIBRATION FAILURE	Label gap sensor was not properly calibrated. This can be due to liner thickness or opacity outside of the system specifications, a faulty connection to the sensor, or the optics require cleaning.
MSG 39	Error	MCM HALL SENSORS	The Hall Effect sensors of the Actuator motor, which determine speed and position of the motor have an issue. Possible causes are disconnected cabling, damaged connector, or damaged motor.
MSG 40	Error	MCM AIR ASSIST	The Air Assist fan output detects a short-circuit. This can be caused by a stalled fan, a damaged fan circuit, or the shorting of the cable leading to the fan.
MSG 41	Error	MCM RETRACT TIMEOUT	The MCM allows up to 10 seconds for the actuator to return to the home position after extension. If it does not return in time, this error is generated.
MSG 42	Error	MCM EXTEND TIMEOUT	The MCM allows up to 10 seconds for the actuator to leave home and travel to the final position. If the actuator exceeds this time, this error is generated.
MSG 43	Error	MCM VACUUM FAN	The MCM monitors the fan output for a short-circuit. This can be caused by a stalled fan, a damaged fan circuit, or the shorting of the cable leading to the fan.
MSG 44	Informational	PRINT ENGINE BUSY	The print engine has exerted the flow control signal to stop sending data. On the SATO, this can occur when the printer is offline. On the Zebra, this can occur while the engine is powering up, and is not receiving communications.
MSG 45	Informational	INCORRECT USB FORMAT	The USB connected does not have the right format. FAT or FAT32 are acceptable formats.
MSG 46	Error	STAND HALL SENSORS	Motorized stand motor issue. Hall sensor connection may be damaged.
MSG 47	Error	STAND DOWN ERROR	Motorized stand move down issue. There may be an obstruction.
MSG 48	Error	STAND UP ERROR	Motorized stand move up issue. There may be an obstruction.
MSG 49	Error	STAND MOVE TIMEOUT	The stand times out during moving up or down because it did not see the home position or up limit sensor.
MSG 50	Informational	SAVING USER DATA	The system is saving setting on the microSD card and it should not be turned off or setting be changed.
MSG 52	Informational	FIRMWARE LOAD COMPLETE	The firmware load on U2 chip or MCM II is complete.
MSG 50	Informational	FIRMWARE LOAD FAILURE	The firmware load on U2 chip or MCM II failed.

Section 6: User Interface How To Guide

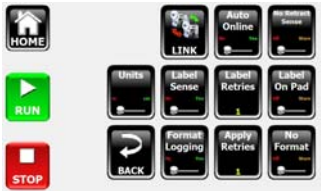
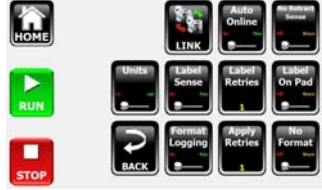
How Do I...	Solution	Screen	Screen Shot
<p>Have the system power up in an Online mode?</p>	<p>Switch the Auto Online to YES</p>	<p>SMART</p>	
<p>Maintain a one-to-one label to product synchronization?</p>	<p>Using the optional Label Present sensor capabilities, set the Label Retries to 1 and Apply Retries to 1. This utilizes two prevention methods: 1. Only one label will be printed and if the label is removed prior to application, the system will halt in an Error condition. 2. If the label is not applied to the product, it will not be applied to the next product.</p>	<p>SMART</p>	
<p>Prevent applying a prior batch's label when placing the system online</p>	<p>Using the optional Label Present sensor, set the Label On Pad to Warn. If the system is online, and there is an existing label on the pad, a warning will inform the user that a possible out of date or incorrect label is on the tamp pad from a prior run.</p>	<p>SMART</p>	
<p>Run batch 1 product labels of a variable quantity and then switch to batch 2 without mislabeling the first product of batch 2?</p>	<p>Use the Make Label with P1 Detect (using one sensor) or P2 Detect (using two sensors) to only generate a label on the detection of a product. If one sensor is used, there must be enough Apply Delay to allow the label to be printed before Applying. The label format should either be prefaced with a clear batch command, in order to clear the last format.</p>	<p>LABEL</p>	
<p>Save formats from the USB Memory Stick to the Internal microSD card (eliminate having a USB stick inserted)?</p>	<p>To transfer label formats from the external USB Memory device to the internal microSD card, switch the Save Info direction to SYS. Press the Save Formats or Save ALL button, and the System will begin transferring label formats with *.fmt or *.lbl extensions to the microSD card. The formats can be nested in separate directories, but not deeper than one level. I.e. - "\WALMART\filename.lbl", "\TARGET\filename2.lbl", etc. Use Save All to create new directories.</p>	<p>FILES</p>	

How Do I...	Solution	Screen	Screen Shot
<p>Upgrade the firmware?</p>	<p>First, contact Technical Support to get the appropriate upgrade file. Place this file on a USB Memory device in the root directory.</p> <p>The Firmware button will be visible if the hex file is located. To upgrade MCA firmware, press the Firmware button. The system will reboot after the firmware is upgraded.</p> <p>To upgrade IO Controller firmware, press the U2 Firmware button. "Upgrading IO Firmware" message will be visible while the upgrade is underway. This upgrade may take a few minutes. After upgrade is completed successfully, MSG 52 is visible. It is necessary to cycle power for upgrade to take place.</p> <p>To upgrade MCM II, press MCM II Firmware button and follow the same procedure as IO Controller firmware upgrade.</p> <p>Do not remove the USB Memory device until it successfully loads, or the load will end in failure with an inoperable system.</p> <p>Please note that during or after U2 and MCM II firmware upgrades, the screen may change to the Connection Menu screen. Wait for the Connect button to turn green to go back to the Home Screen.</p>	FILES	
<p>Automatically save formats at the System that are sent over the Network (or Serially)?</p> <p>Capture a format sent to the System to analyze?</p>	<p>By switching Format Logging to YES, the formats sent to the System are recorded to memory. If the label format uses a naming feature, such as NiceLabel does with SATO formats, the name on the PC will be used to save the label on the microSD card. If no name is provided, the System will give the format a LAST_FORMAT.fmt name. This file can then be saved to a removable USB Memory device, and reviewed on a text editor. Please keep in mind that the LAST_FORMAT.fmt will be overwritten upon the reception of the next format.</p> <p>This functionality can be useful for quickly recalling a format after a power loss, or other situation where the last format can be recalled on the system. Please keep in mind that variable fields and/or sequential indexes will be lost, if utilized.</p>	SMART	
<p>Get notified that the system's Auto Retract Sensor is not seeing the product, and returning home due to duration or another reason?</p>	<p>By switching the No Retract Sense to Warn, the System will display an Informational message box when the actuator returns home for another event, such as Apply Duration or Hit Contact Sense. This is useful to ensure the system is seeing the product, and that the time duration set is not too short, where the system is alternating the return response.</p>	SMART	
<p>Change languages.</p>	<p>Under INFO menu, press Language button, then press the desired language. When the language is selected, the screen changes to Home.</p>	HOME	

Appendix A: Specifications

Technical Specifications

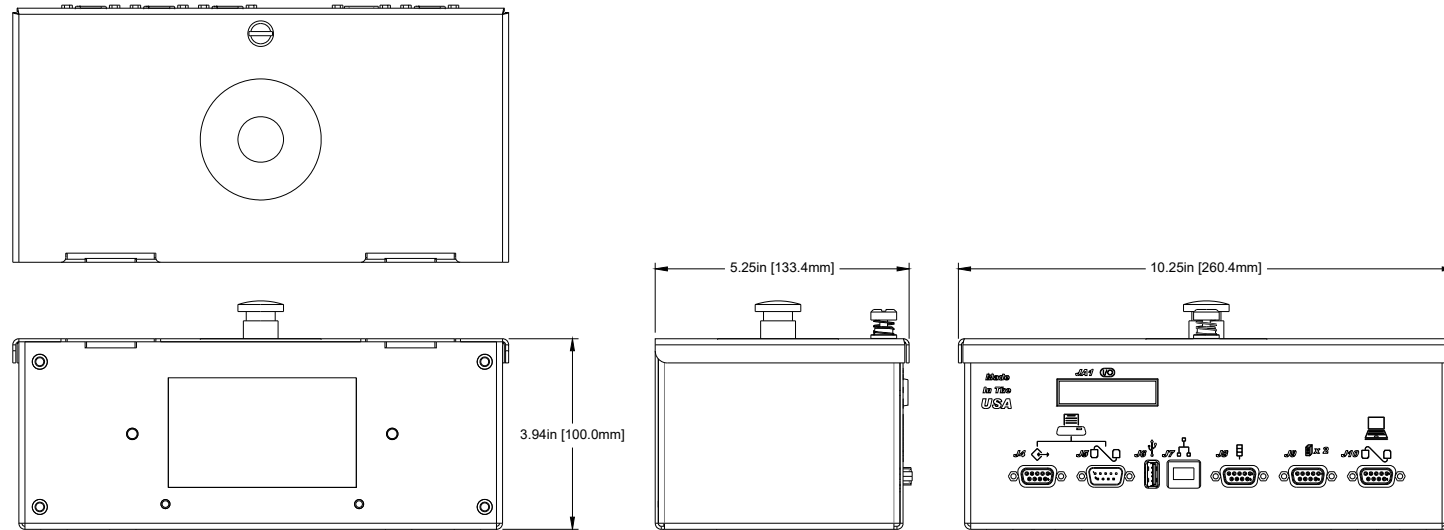

Size

Height: 3.94in [100.0mm]
Width: 10.25in [260.4mm]
Depth: 5.25in [133.4mm]

Enclosure

Aluminum

User Interface

Graphical User Interface

Storage

MicroSDcard

Ports

(2) RS-232 ports
(1) USB port
(1) Ethernet port
(3) DB9 Ports

Electrical

24VDC from power supply to controller.
Power supply: 90-260 VAC, 50/16 Hz, 4A max.

Environmental

Ambient operating temperature: 41°F to 104°F (5°C to 40°C)
Operating humidity: 10% - 85%, non condensing.

Interconnection Diagram

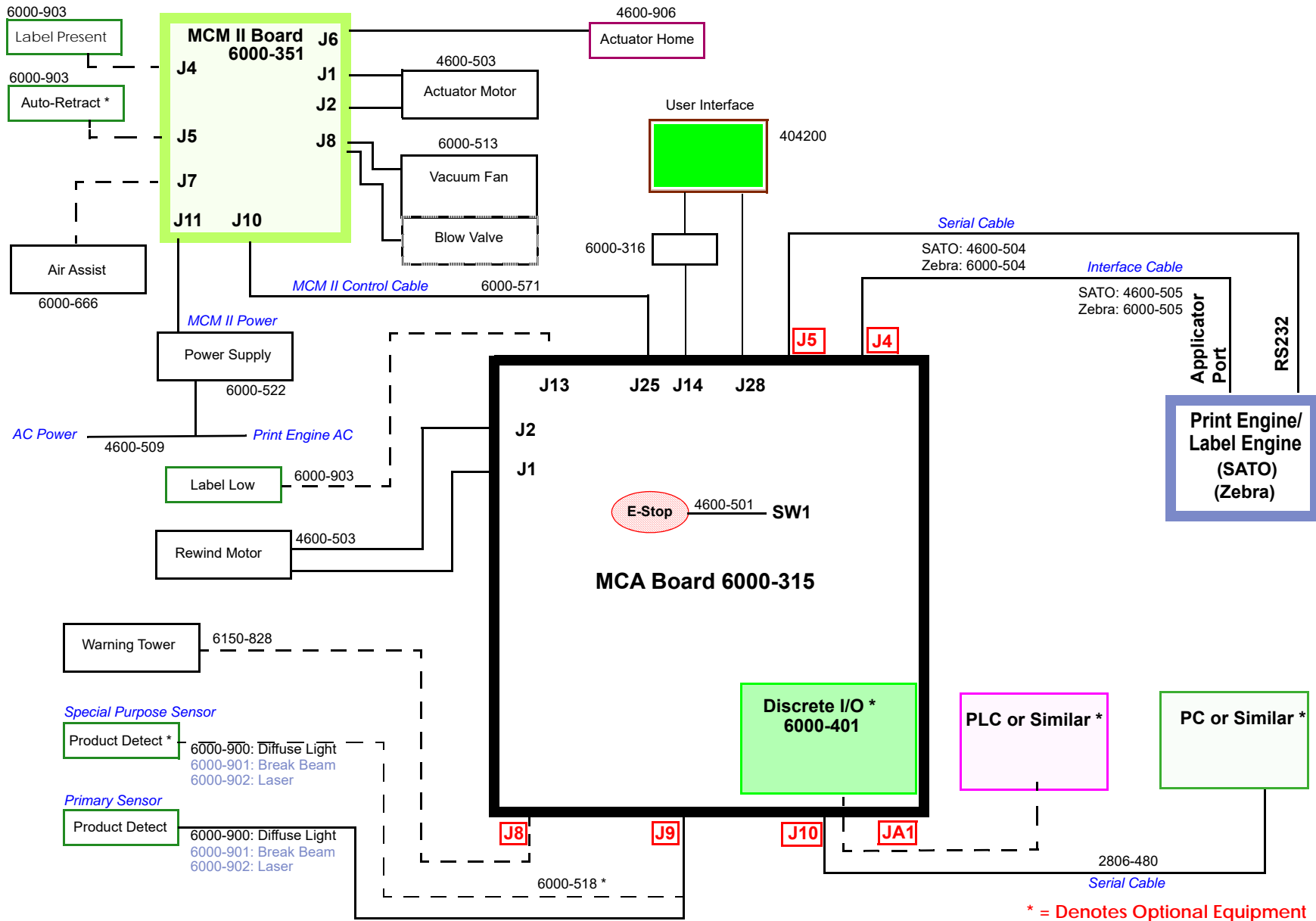

Electrical Interfacing

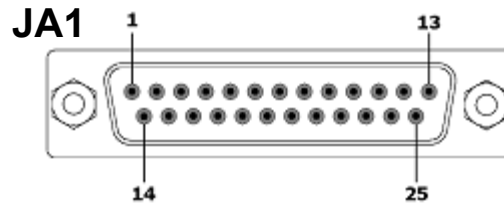

JA1 - Discrete I/O {Optional Connector Presence}			
PIN	Pin Description	PIN	Pin Description
1,2	Out Relay 1A, 1B	13	Ground
3,4	Out Relay 2A, 2B	14,15	In A+, In A-
5,6	Out Relay 3A, 3B	16,17	In B+, In B-
7,8	Out Relay 4A, 4B	18,19	In C+, In C-
9,10	Out Relay 5A, 5B	20,21	In D+, In D-
11,12	Out Relay 6A, 6B	22,23	Ground
		24,25	+24 VDC FUSED 0.5 A

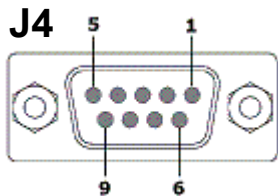

J4 - Module Control	
PIN	Pin Description
1	Ground
2	MODULE 5 VDC
3	Label Start
4	Label End
5	Label Out
6	Reprint
7	Ribbon Out
8	Module Error
9	Ribbon Low

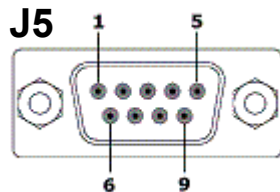

J5 - Module Serial	
PIN	Pin Description
1, 4, 6	N/C
2	RS232 TX (to Module)
3	RS232 RX (from Module)
5	Ground
7	
8	
9	+ 5 VDC

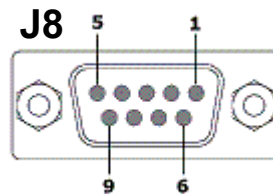

J8 - Warning Tower	
PIN	Pin Description
1, 3	Ground
2	Aux Input (NPN)
4	Red (Ground Switched)
5	Yellow (Ground Switched)
6, 9	+ 24 VDC Supply
7	Green (Ground Switched)
8	Aux Output (Sinking)

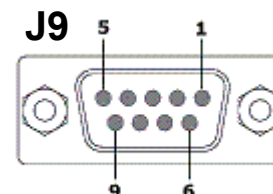

J9 - Product Detector(s)	
PIN	Pin Description
1, 2, 5	N/C
3	Ground
4	Product Detect Input 2 (NPN)
6	+ 24 VDC Supply
7,9	N/C
8	Product Detect Input 1 (NPN)

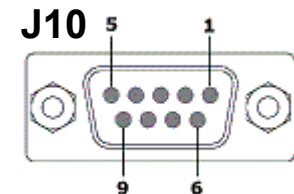

J10- Serial Communication	
PIN	Pin Description
1, 4, 6	N/C
2	RS232 TX (to PC/PLC)
3	RS232 RX (from PC/PLC)
5	Ground
7	N/C
8	N/C
9	+5 VDC

Theory of Operations

The MCA uses a micro computer to handle all of the user interface graphics, USB and microSD file actions, Ethernet and serial communication, and real time clock. It employs a dedicated I/O controller processor to handle all of the time-critical events and maintain timing accuracies to less than 1 millisecond. Since the system settings are located on the internal microSD card, the user must return to the Home Screen to save changes to the settings.

General notes for the MCA Controller:

- Some buttons will not be visible due to the current settings. All button are shown here for clarity.
- If there is a warning (yellow message box), it can be cleared by pressing the message box. Press the **Run** button to change the mode back to Online **OK**, which resets the message warnings and the warning tower to green.

Appendix B: Configuring a Discrete I/O Module

Navigation, Electrical Input & Output Characteristics

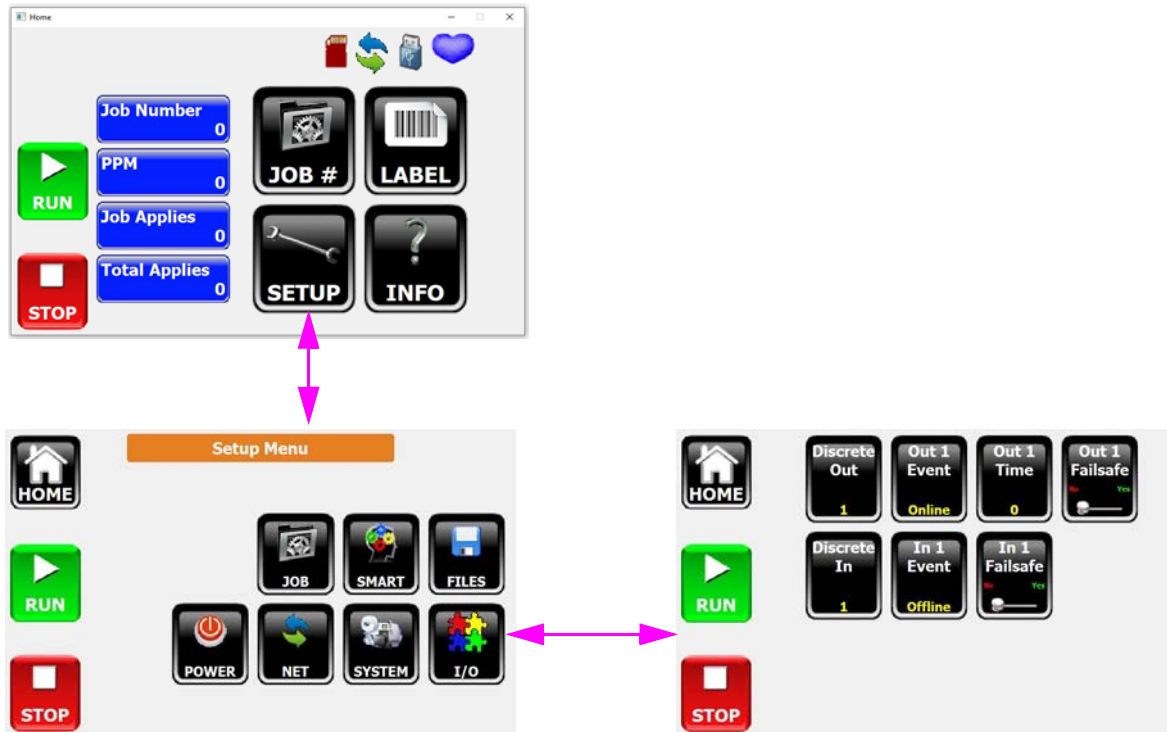

Discrete Outputs Electrical Characteristics

There are six (6) solid state isolated outputs that are each capable of switching up to 400 mA of current with a maximum voltage of 24 Volts AC or DC. Since these outputs are “closing contacts” in nature, they require a power source on one lead of the contact to flow current to the circuit it is connected to. The Discrete I/O module provides a fused 24 VDC source, limited to 0.5 Amps for this purpose. The bank of 6 dipswitches on the IO Card allow the common side (B-side) of the relay to be connected to the fused 24 VDC internal power.

Discrete Input Electrical Characteristics

There are four (4) optically-isolated inputs that are activated by supplying them a voltage source between 5 to 24 VDC with 25 mA minimum current. Each input has two differential lines that require a source of current to flow to activate an input event. The Discrete I/O Module’s built-in 24 VDC source is a good choice for powering an input, utilizing an external relay or solid state output from the connecting device to open and close the contact and control the event input. The bank of 4 dipswitches on the IO Card allow one side of the input channel to be connected to ground, to reduce external connections.

I/O Input & Output Events

Discrete Output Events

The individual output line can be selected with the **Discrete Out** toggle button. The predefined events are listed in the table to the right. The output duration can be set to a value in milliseconds, or set to zero. For certain events, this may not be useful, because they may have multiple occurrences.

Output Event	Description	Out Time
• None	No output event selected	None
• Media Out	Label and/or Ribbon supply is exhausted	0 or time acceptable
• Media Low	Label and/or Ribbon supply is low	0 best, can multiple trigger
• Online	Unit is online (ready to print and apply)	0 or time acceptable
• No Format	There is no format in the printer to print	0 or time acceptable
• Error	Unit is offline, due to error	0 or time acceptable
• Warning	Unit has experienced a condition that requires attention, but it is still able to run online	0 best, can multiple triggers
• Cycle End	The apply cycle is finished	0 or time acceptable
• Cycle Start	The apply cycle is beginning	0 or time acceptable
• Pad Label	The label is present on the tamp pad	0 best, can multiple triggers
• Stand Ready	The Stand is ready for operation	0 or time acceptable
• Actuator Home	Actuator is at Home position	0 or time acceptable

Discrete Input Events

Of the four (4) input signal lines, any of them can be configured for any of the predefined system events. Multiple inputs can be configured to the same event for various application reasons. Each input can be individually set to Failsafe mode, where the trigger is an absence of the signal voltage to the input.

Input Event	Description
• None	No input event assigned
• Online	Enter online mode. Cannot enter online mode if there is an error.
• Offline	Enter offline mode.
• Product Detector 1	Trigger product detector 1 signal. This can start the print cycle (if print activation is set for Prod Sens 1), and start the apply cycle.
• Product Detector 2	Trigger product detector 2 signal. This can start the print cycle (if print activation is set for Prod Sens 2).
• Error	This input allows an external device to halt operation, resulting in an error.
• Warning	This input allows an external device to flag a warning, resulting in a yellow warning tower and display state.
• E-Stop	This input allows an external device to flag E-Stop which results in system soft power off.
• Resync	Send the Resync signal to system 1 or 2.
• Stand Up	Move the applicator up the stand.
• Stand Down	Move the applicator down the stand.
• Stand Stop	Stop the applicator from moving.
• Stand Seek	Look for the top of the product.

Interfacing I/O Inputs & Outputs

Interfacing the Outputs

Typical Output Circuit on Discrete I/O Module.

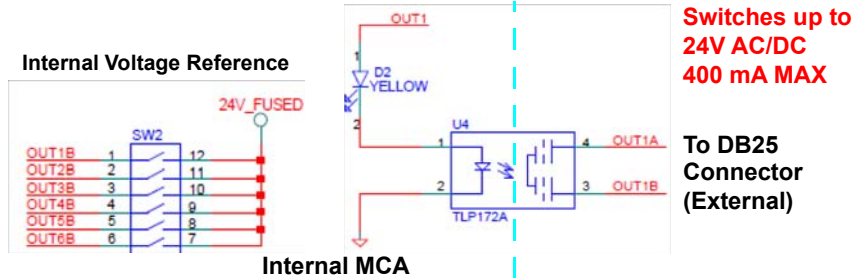

Example Hook-Ups

Connection to PLC from MCA Output, MCA Sourcing Power

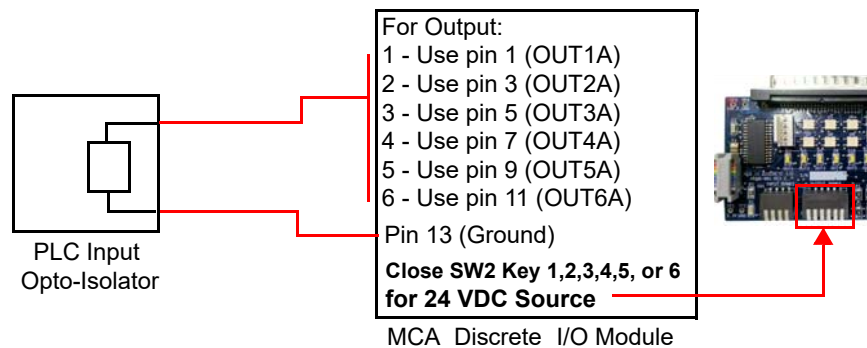

Connection to High Power Relay from MCA Output

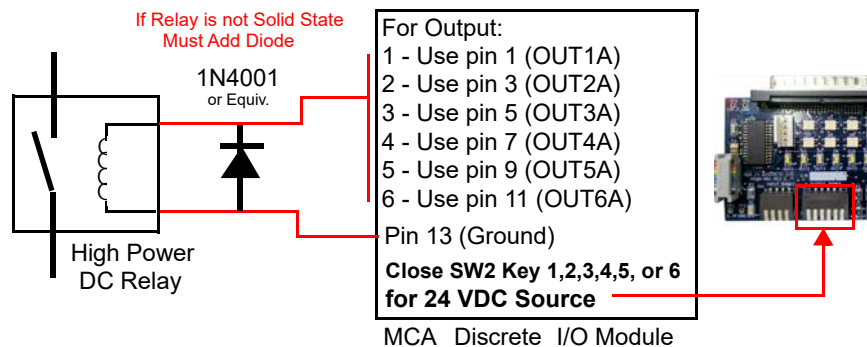

Interfacing the Inputs

Typical Input Circuit on Discrete I/O Module

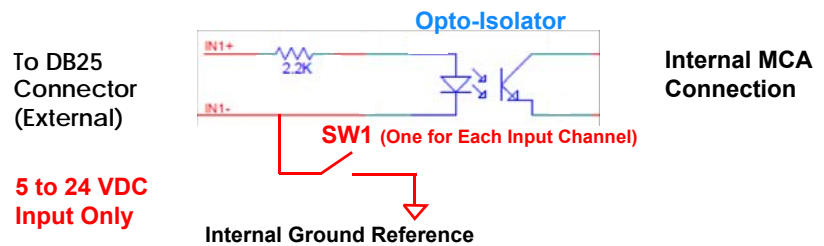

Example Hook-Ups

Connection to PLC or Pushbutton triggering MCA Input, MCA Sourcing Power

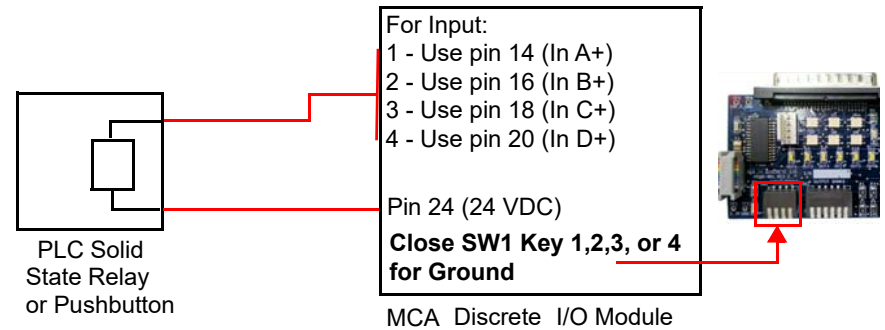

Connection to PLC triggering MCA input, PLC Sourcing Power

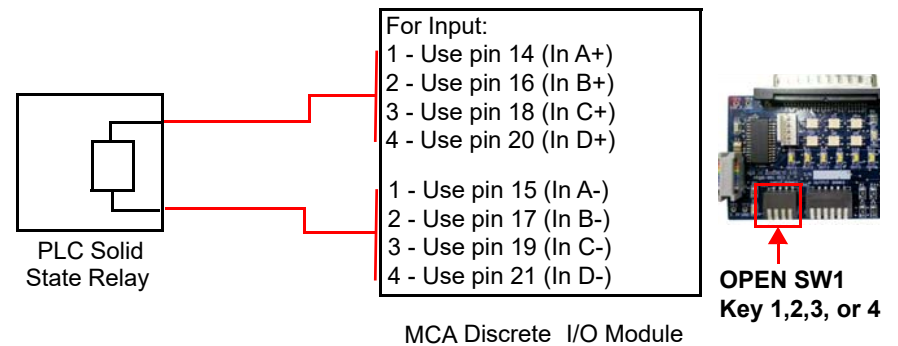

Appendix C: Product Detector

Product Detector for the Application

The standard product detector offered is the Diffuse Light 4600-900 sensor. There are two optional sensor types, one is a break-beam sensor, and the other is a laser with background suppression. The proper product detector can make the difference in label placement and operation

Product Detector Selector			
Application Detail	Diffuse Light (4600-900)	Break-Beam (4600-901)	Laser (4600-902)
Corrugated brown case, no pre-print	✓	✓	✓
Corrugated brown case, pre-print	x	✓	✓
Tray packs with product gaps in pack	x	✓	✓
Pallets	✓	✓	x
Shrink wrapped products	x	✓	✓
Primary product	✓	✓	✓
Primary product, high speed, high accuracy	x	x	✓

Product Detector Adjustments

All three of the sensors have the same controls for adjustment. Setting S2 (as shown to the right) controls the sensitivity of the detector. With a sample target product in front of the sensor, adjust this setting. The output LED, L2 in the image, will illuminate with the sensitivity adjustment is correct. The power LED, L1 in the image, will show the signal return strength when the output LED is on. Make sure the sensitivity is set so the green LED is on solid so that slightly less reflective products will still cause a trigger. Once the product is removed from the field of view of the sensor, the green LED will return to indicating power, and will be strongly illuminated. For break-beam applications using the 4600-901 sensor, the Light/Dark setting S1 should be changed. This inverts the output signal mode to the applicator. Since a break-beam application will normally have an active output for no product detected, the change of S1 will allow the triggering to react to the presence of the product.



Appendix D: Create the Label Format

Create the label format

Printer Configuration

Although label software programs will differ in look and functionality, there are some key similarities. Most importantly, the correct driver for the printer should be selected.

Shown below are typical screenshots from NiceLabel, which is the premiere software package that Illinois Tool Works offers.

Select the baud rate, and other communication-specific parameters. This is typically found under the Windows>Printers> select *specific printer* >Properties>Ports> select *port number* >Configure Port.

In the program's printer setup screens, check to make sure:

- Cutter is not selected
- **Backfeed Before Print** (suggested)
- Continuous Print is not selected
- Speed is set to a rate optimal for both print quality and throughput requirements
- Label size entered matches the actual label dimensions
- Darkness is set for good quality print and long life operation

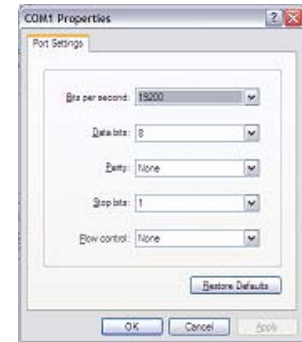

Create your format with text, barcodes, graphics, and other required fields. Try to use printer resident fonts and functionality (such as time, date, and counters), which will greatly reduce download time. Once created, send the format with the desired quantity and adjust positioning as required.

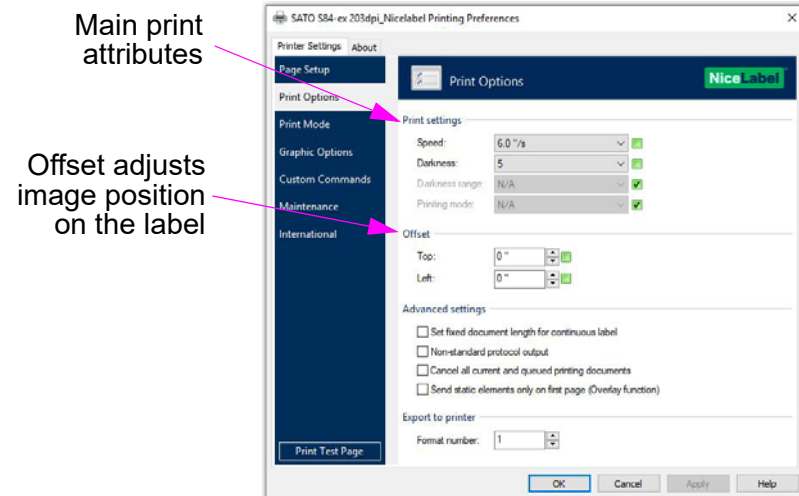
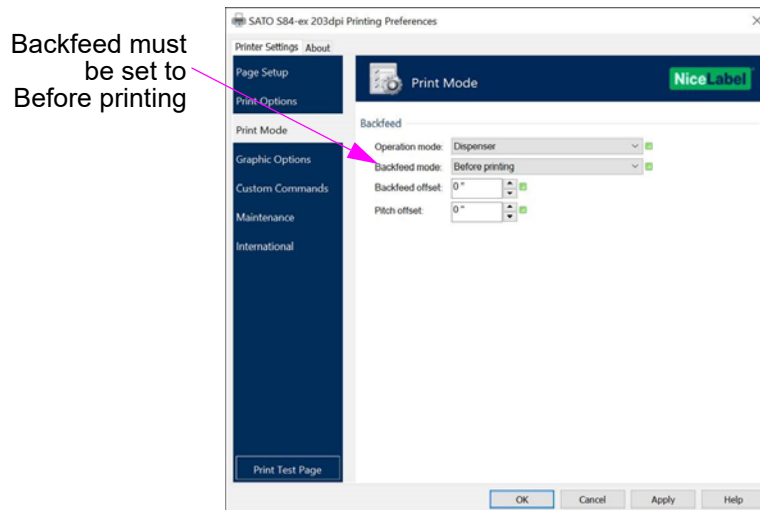

Recall Label Formats from USB Drive

USB Overview

The USB memory storage option allows the recall of a static (non-changing) label format through the user interface. The maximum number of formats that can be stored is only limited by the size of the USB memory device. From the Label Menu, a label can be sent to the printer from the Recall screen. Once the format is selected, it is sent to the printer with the information and quantity defined when the format was created. Internal printer functions for time, date, and sequential counts can be used to create “born-on” or “sell by/best by” information, provided the label software uses the built-in printer capabilities.

Loading Formats onto the USB Drive

The format loaded onto the USB Drive will depend on which brand of printer is utilized in the labeler. For SATO, the saved file should be an ASCII text file in SATO Programming Language (SPL) and ZPL for Zebra. The format stored on the drive should not be the label file saved from the label program. The format should be an exported or “print to file” version of the format, which would be the output from the label software to the printer. The ASCII export file can have whatever name desired, but only a limited number of characters can be displayed. Use either “prn” or “fmt” as the file extension, so that the system will recognize this as a label format file.

For variable fields, such as date, time, or sequence count, the format will need to use printer-specific commands to utilize internal functions. In many label software programs, there is a choice in the properties menu for the particular field to utilize internal printer functions. This will require the use of printer-resident fonts and barcodes. Once the formats are loaded on the drive, it can be inserted into the back of the MCA in the USB slot.



Recalling Formats

To recall a format from the USB or internal microSD Drive, press the **Recall** button and select the format by using the arrow up and down buttons. When the desired format is located, press the name of the format once to select it, and once again to send it to the printer. It is important that the system baud rate matches the printer baud rate. The format will contain the quantity that was stored with the label when it was designed. A typical practice is to send a large quantity (more than will be needed), and then clear the batch before sending the next one. This is easily done with the **Clear** button on the Label Menu screen.

Recall Label Formats with Scanner (Optional)

Scanner Recall Overview

Using a handheld USB scanner (Honeywell Voyager), the MCA can recall formats stored in the microSD memory card. Before this is possible, the format must be created, printed to file, and transferred from the USB memory device to the internal memory card. The prior sections describe how this is accomplished. In addition to recalling a saved format, there is a built in command barcode to clear the existing batch jobs in the printer.

Once the label formats have been transferred to the microSD memory of the MCA, the user must create a set of barcodes that will recall the format. This should be performed with the label format software, such as NiceLabel, but instead of printing this to a print engine or saving the format to a print file, the user can select a standard desktop printer to create a recall “cheat sheet” to be used at the labeler. In this fashion, multiple recall barcodes can be placed on the sheet, along with a human readable text designator next to them.

Setup

The recall barcode should be created as a Code 128 with a 13 mil. size. There is a standard prefix for label recall, which will be required on all of the barcodes used to recall a format. Use *WKwsFN* as this prefix with the proper path of the format on the MCA. For the microSD card, *\SD* would be the path. For the USB memory stick, *\USB* would be the path (this would require a USB hub to plug in both devices at the same time). For example, if the format is stored on the microSD card, and the file name is *Format1.fmt*, then *WKwsFN\SD\Format1.fmt* should be used as the Code 128 data. To recall one of the built-in test formats for a SATO printer, the recall code would be *WKwsFN\SD\ SATO TEST 4x2.tfmt* which is seen in the barcode example below.

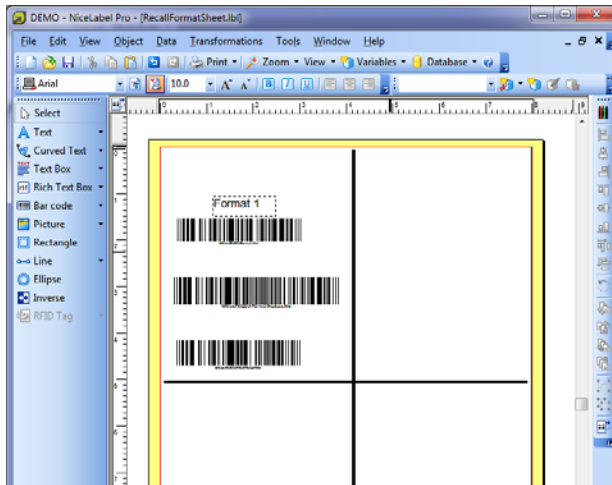

Recall test format SATO TEST 4x2.tfmt from Controller



Clear Batch

Additional Commands

Clear Printer Jobs, Code 128 as *WKwsCB*.

Change MCA Job Number as *WKws02####* , where *####* equals the job number with leading zeros (i.e. - switch to Job 3 = *WKws020003*)

Appendix E: Communicating to MCA

MCA can communicate commands and responses through RS232 and wire Ethernet from and to other devices. Refer to the MCA command set document 6000-301N for commands and responses.

Appendix F: Redundant System

MCA has a built-in firmware function to handle redundant mode between two systems. The link is established through the wired Ethernet connection on the MCA module.

In this mode, the primary system runs while the secondary is offline. Once the primary system is unable to apply labels, due to error, goes offline, or other situation where it cannot apply, the secondary system is onlined and ready to apply. Once the primary has been restored to a working state, and the secondary system is offlined or the primary system is onlined, the secondary system will go offline and the primary will go online and again perform the labeling responsibilities.

The Linked System Number is the last Ethernet IP octet of the linked system. For example, if the IP address of primary system is 172.16.2.10 and the linked secondary system is 172.16.2.11, the Linked System Number for primary system would be 11 and on the secondary system, the number would be 10.

Both systems will remain offline to start. Once the first system is onlined, the other system will be forced to offline.

NOTE: The first three octets of the IP address of both systems must be the same.

NOTE: If the Ethernet Cable is disconnected from either system, both systems will be on-line. To fix, power-down both systems and reconnect the Ethernet cable; then power-up the systems.

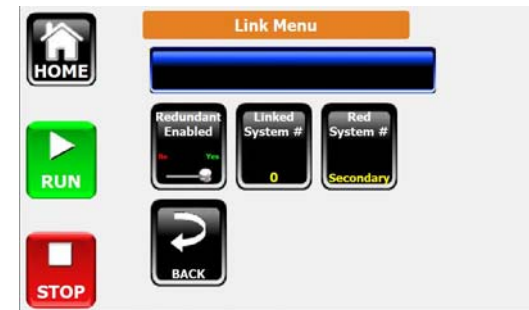

MESSAGES

Message	Meaning
Other System is Forcing: Online	A message was received from linked system to put this system online.
Other System Forcing: Offline	Linked system is forcing this system to go offline.
PINGED: PRIMARY ALIVE	Secondary system lost communication with the primary system and has now reconnected with it.
NOT PINGED: PRIMARY LOST: x	Secondary system has lost communications with the first system x number of times.
COM LOSS:x	This system has been unable to communicate to the linked system x times.
Other System Off > This System On	Linked system determined other system if off, so put this system online.
Other System Offline. OV=1	Turn override on (every product application) because other system status is offline.
Other System Online. OV=0	Turn override off (every other product application) because other system status is online.
Going Online. Put Other in OV=0	This system is going online, so place linked system into override off.

Appendix G: MCA Remote Controller

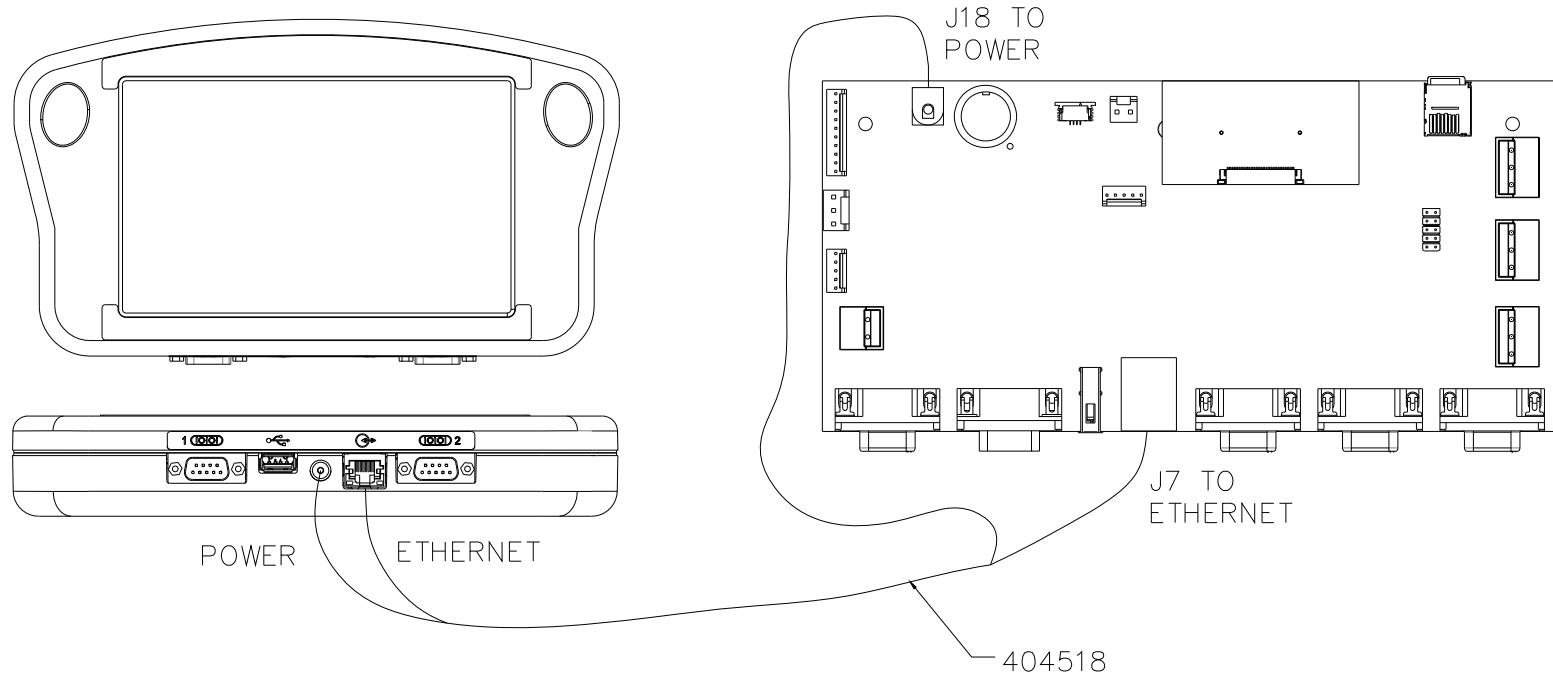

Appendix H: Part Numbers

System

Major Components

Item	Kit No.	Description
1	404201	Kit, MCA PCB and Enclosure

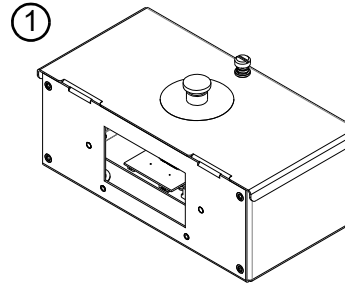

Replacement Kits

Display and PCB

Item	Kit No.	Description
1	404200-LS7000	Kit, 18cm (7") Display, LS7000
	404200-LS7100	Kit, 18cm (7") Display, LS7100
2	404202	Kit, MCA PCB and Display Board

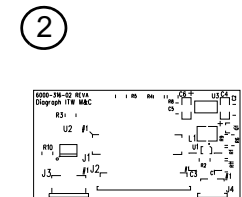
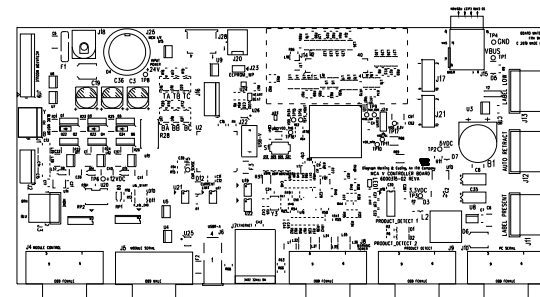
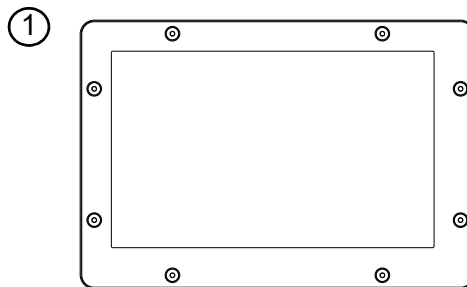

Optional Equipment

Encoder, Warning Tower & Photocell

Item	Kit No.	Description
1	6000-828	3 Color Warning Tower
2	6000-828AUD	3 Color Warning Tower with Audible Alarm
3	4600-901	Product Sensor, Break-Beam
4	4600-902	Product Sensor, Laser
5	6000-405	Discrete I/O Module
6	6000-518	Product detector Y-Cable
7	5780-017FXALP	MCA Remote Controller Kit

